

UNCLASSIFIED

NOTICE: When government or other drawings, specifications or other data are used for any purpose other than in connection with a definitely related government procurement operation, the U. S. Government thereby incurs no responsibility, nor any obligation whatsoever; and the fact that the Government may have formulated, furnished, or in any way supplied the said drawings, specifications, or other data is not to be regarded by implication or otherwise as in any manner licensing the holder or any other person or corporation, or conveying any rights or permission to manufacture, use or sell any patented invention that may in any way be related thereto.

NOTICE:

THIS DOCUMENT CONTAINS INFORMATION AFFECTING THE NATIONAL DEFENSE OF THE UNITED STATES WITHIN THE MEANING OF THE ESPIONAGE LAWS, TITLE 18, U.S.C., SECTIONS 793 and 794. THE TRANSMISSION OR THE REVELATION OF ITS CONTENTS IN ANY MANNER TO AN UNAUTHORIZED PERSON IS PROHIBITED BY LAW.

UNCLASSIFIED

UNCLASSIFIED

359287

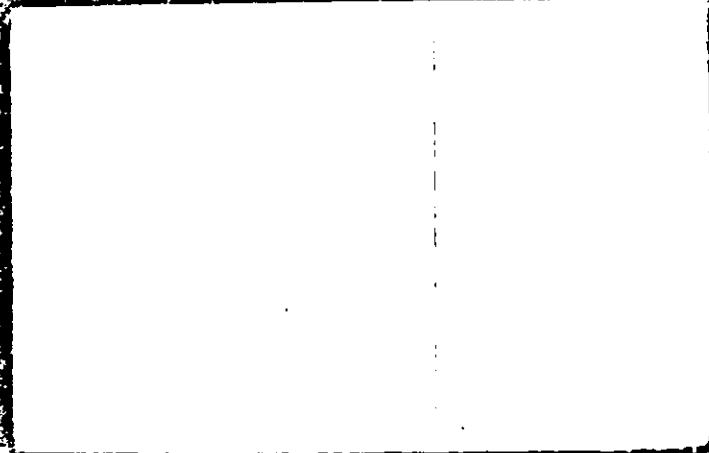

UNCLASSIFIED

UNCLASSIFIED

GENERAL DECLASSIFICATION SCHEDULE

IN ACCORDANCE WITH
DOD 5200.1-R & EXECUTIVE ORDER 11652

THIS DOCUMENT IS:

CLASSIFIED BY _____

Subject to General Declassification Schedule of
Executive Order 11652-Automatically Downgraded at
2 Years Intervals-DECLASSIFIED ON DECEMBER 31, 1972

BY

Defense Documentation Center
Defense Supply Agency
Cameron Station
Alexandria, Virginia 22314

UNCLASSIFIED

UNCLASSIFIED

D 359287

DEFENSE DOCUMENTATION CENTER

FOR

SCIENTIFIC AND TECHNICAL INFORMATION

CAMERON STATION, ALEXANDRIA, VIRGINIA



UNCLASSIFIED

UNCLASSIFIED

CSH-80-126-10

14 Rep. nos. DEC-63-12363

28 February 1963

GUERRILLA ACTIVITY DETECTION STUDY (U.S.)

DEFENSE RESEARCH CORPORATION

SANTA BARBARA, CALIFORNIA

FINAL REPORT - 1 April 62 - 30 Jan 63

by E. M. Gardner, M. Z. Gagnier, R. D. Haddock and I. F. Haddock

1 April 1962 through 30 January 1963

15 Contract SR-26

Prepared For

THE ADVANCED RESEARCH PROJECTS AGENCY

Office of the Secretary of Defense
Director of Defense Research and Engineering
Pentagon, Washington, D. C.

DDC CONTROL NO. 51660
T: SIA F

DDC CONTROL NO. 51660

UNCLASSIFIED

DOWNGRADED AT 3 YEAR INTERVALS;
DECLASSIFIED AFTER 18 YEARS
DOD DIR 5300.10

#411

UNCLASSIFIED

~~SECRET~~

ESPIONAGE ACT MARKING

This material contains information affecting the national defense of the United States, within the meaning of the Espionage Laws, Title 18, U. S. C., Sections 793 and 794. The transmission or revelation of which in any manner to an unauthorized person is prohibited by law.

DOWNGRADED AT 3 YEAR INTER-
VALS; DECLASSIFIED AFTER
12 YEARS
DOD DIR 5200.10

11

~~SECRET~~

UNCLASSIFIED

SECRET

UNCLASSIFIED

TABLE OF CONTENTS

	<u>Page</u>
PART ONE - FINAL REPORT	
Foreward	xi
Abstract	xii
Section 1 INTRODUCTION AND SUMMARY	1.1
Section 2 REQUIREMENTS	2.1
2.1 General	2.1
2.2 Environmental Factors	2.4
2.3 Operational Considerations	2.7
Section 3 METHODS	3.1
3.1 Introduction	3.1
3.2 Optical	3.3
3.3 Radar	3.9
3.4 Acoustical & Geophysical	3.10
3.5 Other	3.10
3.6 Experience	3.11
Section 4 STUDY AND RESEARCH	4.1
4.1 Fire Detection	4.1
4.2 Wake Detection	4.2
4.3 Radar Surveillance	4.3
4.4 Listening and Magnetic Detection	4.3
4.5 Summary and General Comments	4.5

iii

SECRET

UNCLASSIFIED

UNCLASSIFIED

SECRET

TABLE OF CONTENTS (CONTINUED)

Section 5	BIBLIOGRAPHY	5.1
5.1	Philosophy, Strategy & General Tactics ..	5.1
5.2	Operations	5.3
5.3	Limited War Capabilities and War Games .	5.4
5.4	Area Topics of General Interest	5.4
5.5	Bibliographies	5.5
5.6	Infrared Bibliography	5.7
PART TWO - APPENDICES CONTAINING FINAL TECHNICAL SUMMARIES		
Section 6	REQUIREMENTS	6.1
6.1	Environmental Features	6.1
6.1.1	Southeast Asia	6.1
6.1.2	Vietnam	6.4
6.1.3	Thailand	6.6
6.1.4	Detail Maps	6.12
6.1.5	Inferences	6.15
6.2	Operational Considerations	6.17
6.2.1	Historical	6.17
6.2.2	Current	6.25
6.2.3	Future	6.28
Section 7	OPTICS	7.1
7.1	State of the Art of High Resolution Thermal Mappers	7.2
7.2	Fire Detection	7.12

SECRET

UNCLASSIFIED

~~UNCLASSIFIED~~

TABLE OF CONTENTS (CONTINUED)

7.3	Probability Considerations & New Equipment for Fire Detection	7.41
7.4	Wake Detection	7.75
7.5	Comments on Other Applications	7.126
7.6	Background Problems	7.132
7.7	Choice of Detectors	7.136
Section 8	RADAR	8.1
8.1	Personnel Detection	8.2
8.2	Other Applications	8.9
8.3	Summary	8.20
Section 9	ACOUSTICS AND GEOPHYSICS	9.1
9.1	Acoustics Summary	9.1
9.2	Applications Problems	9.33
9.3	Geophysics	9.34
Section 10	MISCELLANEOUS	10.1

~~UNCLASSIFIED~~

~~SECRET~~

LIST OF ILLUSTRATIONS

<u>Figure</u>		<u>Page</u>
1.1	Outline Political Map-Southeast Asia Study Areas.....	1.9
2.1.1	Some Major Areas of Conflict - S. Vietnam.....	2.6
6.1.1	SE Asian Topography.....	6.30
6.1.2	Southeast Asia Rice Bowls.....	6.31
6.1.3	Predominant Land Use - SE Asia.....	6.32
6.1.4	Major Vegetation Types - SE Asia.....	6.33
6.1.5	Distribution of Tropical Rain Forest.....	6.34
6.1.6	Mean Annual Precipitation - SE Asia.....	6.35
6.1.7	Relief Map - Indochina.....	6.36
6.1.8	Crops and Land in Indochina.....	6.37
6.1.9	Regional Map - Thailand.....	6.38
6.1.10	Topography - Thailand.....	6.39
6.1.11	Regions of Thailand.....	6.40
6.1.12	Seasonal Flooding - Bangkok Plain.....	6.41
6.1.13	Bangkok Plain Rice.....	6.42
6.1.14	Agriculture Areas.....	6.43
6.1.15	Natural Cover.....	6.44
6.1.16	Agriculture & Forests.....	6.45
6.1.17	Mean Rainfall.....	6.46
6.1.18	Selected Khoret Rainfall.....	6.47
6.1.19	Population Density of Thailand.....	6.48
6.1.20	Major Ethnic Groups of Thailand.....	6.49
6.1.21	Detailed (TeCIA) Map Areas.....	6.50

~~SECRET~~

~~SECRET~~

LIST OF ILLUSTRATIONS (CONTINUED)

<u>Figure</u>		<u>Page</u>
6.1.22	SW of Bangkok.....	6.51
6.1.23	W of Bangkok.....	6.52
6.1.24	Bangkok.....	6.53
6.1.25	E of Bangkok.....	6.54
6.1.26	Saigon Area.....	6.55
6.1.27	S of Saigon.....	6.56
6.1.28	SE of Saigon.....	6.57
6.1.29	Camau Peninsula.....	6.58
6.1.30	Terminus Region.....	6.59
6.1.31	DaNang.	6.60
6.1.32	W of DaNang.....	6.61
6.1.33	East Portion 1:50,000 Map DaNang.....	6.62
6.1.34	West Portion 1:50,000 Map DaNang.....	6.63
7.2.1	Transmission - Forest Site 1.....	7.37
7.2.2	Transmission - Forest Site 2.....	7.38
7.2.3	Transmission - Forest Plot 3.....	7.39
7.2.4	Transmission - Forest Plot 4.....	7.40
7.3.1a	Average Probability to See at least one of the Targets Under Canopies of Various Densities.....	7.70
7.3.1b	Number N of Targets, that lead to a Set Average Probabi- lity of Seeing at Least one of the Targets vs Canopy Density.....	7.71
7.3.3a	Average Probability of Seeing in an Attempt, Exactly K of 12 Targets Under a Canopy of Density = 0.85 ₁	7.72

~~SECRET~~

LIST OF ILLUSTRATIONS (CONTINUED)

<u>Figure</u>		<u>Page</u>
7.3.3b	Average Probability of Seeing in an Attempt, at Least K of 12 Targets Under a Canopy of Density = 0.85 ₁ ...	7.73
7.4	A Method of Scanning for Openings, A significant Por- tion of Canopy to Find Unobstructed Lines of Sight to Point Target.....	7.74
7.4.1	Basic Data Experiment	7.123
7.7.1a	Most Sensitive Detectors - 0.3 - 15 Microns.....	7.137
7.7.1b	Detectivity of Single-Element Detectors for the Spec- tral Region between 1.5 and 70 Microns.....	7.138
9.1.1	Contour Lines of Equal Loudness.....	9.24
9.1.2	Nomogram - Relationship Between Loudness in Sones and Loudness Level in Phons.....	9.24
9.1.3	Audibility in the Presence of Noise.....	9.25
9.1.4	Mean Frequencies of Bands of Equal Contribution to Articulation Index.....	9.25
9.1.5	Absorption of Plane Sound Wave.....	9.26
9.1.6	Terrain Loss Coefficients.....	9.26
9.1.7	Masking Level Curves, Las Cruces Jungle.....	9.27
9.1.8	Masking Level Curves & Motor Noise.....	9.28
9.1.9	Directional Characteristics of Parabolic Reflector for a Microphone.....	9.28
9.1.10	Index of Refraction for Rigid Element Acoustic Dif- fraction Arrays.....	9.29
9.1.11	Disk Lens for High Frequency Sound Collection.....	9.29
9.1.12	Directional Properties of a High Frequency Acoustic Lens.	9.30
9.1.13	Acoustic Path Lengths.....	9.30
9.1.14	Acoustic Lenses & Prism.....	9.31

SECRET

LIST OF ILLUSTRATIONS (CONTINUED)

<u>Figure</u>		<u>Page</u>
9.1.15	Slant-Plate-Lens-Horn Microphone	9.32
9.1.16	Directional Characteristics of a 29-inch Diameter, 30-inch Focal Length Slant-Plate-Lens-Horn Microphone.....	9.32

~~SECRET~~

LIST OF TABLES

<u>Table</u>		<u>Page</u>
2.1.1	General Requirements for Military Detection	2.3
3 1.1	Existing Guerilla Detection Programs.....	3.2
7.2.1	Characteristics of Selected Sites.....	7.28
7.3.1	Probability of Maintaining Performance.....	7.58
7.5.1	Pertinent Military Infrared Equipment.....	7.127 & 7.128
7.5.2	M-3 Sniperscope/18" Searchlight Performance.....	7.131
8.1.1	Characteristics of AM/PFS-4.....	8.2
8.1.2	Characteristics of AM/PFS-29.....	8.3
9.1.1	Frequency Dependence of Sound Attenuation at 55% Relative Humidity at 80°F.....	9.9
9.1.2	Terrain Loss Coefficients for Jungle at 200 CPS.....	9.11
9.1.3	Noise Levels and Sources.....	9.12
9.1.4	Sound Attenuation in Jungle.....	9.16

~~SECRET~~

FOREWORD

This document is submitted as the Final Report for Contract OSD-126, with the Office of the Secretary of Defense for the Advanced Research Projects Agency. The report covers work accomplished in the period 1 April 1962 through 30 January 1963. Principal contributors include B. Alexander, A. Z. Crispott, R. D. Holbrook, and I. P. Works. Thanks are due to T. C. Basemore, D. R. Bishop, C. A. Moreno, W. W. Short, and V. R. Stull for special contributions.

~~SECRET~~

~~SECRET~~ SECRET

ABSTRACT

↓

This ~~General Report~~ of a short study on detection for anti-guerilla operations in S. E. Asia is divided into two parts. Part One ~~(Sections 1 through 5)~~ is the body of the report containing an intentionally concise description of major findings and recommended programs. Part two ~~(Sections 6 through 10)~~ consists of detailed Appendices and Final Technical Summary Reports, respectively, on requirements, optical studies, radar, acoustic, geophysics, and miscellaneous techniques.

The emphasis of the study has been on novel applications of advanced techniques to logically constructed requirements. Operational and environmental factors are reviewed and a logical set of requirements is offered and solutions to partially satisfy a majority of these are outlined. Two novel applications of advanced infra-red techniques of potentially general applicability are offered. Other applications of infra-red for specialized situations are also suggested. A specific use for an unconventional radar is discussed and preliminary estimates of feasibility are given. A survey of acoustic detection possibilities is provided and the applicability of certain geophysical prospecting techniques is examined. Other ideas of unknown feasibility are listed and briefly discussed.

In all cases either study, research, or test work is needed. A program of study and research is outlined for the methods of major interest and potential. Throughout Part Two comments on desirable investigations are noted at appropriate points.

~~SECRET~~ SECRET

SECRET

SECTION 1

INTRODUCTION AND SUMMARY

This is a final report of a study for the Advanced Research Projects Agency, addressed to the problem of detecting and identifying guerrilla operations in Southeast Asia. Three factors were to be considered: the requirements for, and the performance necessary, in operational equipments for use by indigenous troops; the applicability of existing equipments; and the potential utility of principles and methods not in current use. The study was to define those laboratory and field tests required for assessment of the usefulness and effectiveness of suggested methods, including certain technical evaluations as directed by ARPA.

Subsequent direction defined the following constraints: The study should be concerned with equipment for military operations solely, and not with police, or covert intelligence equipment. The study should concentrate on detection ideas and methods not already under intensive investigation by the various Services. Extensive systems analysis to determine requirements was not desired.

The motivations for such a study are plain. First, the location of guerrillas under conditions that permit successful attack by friendly forces remains one of the great problems of anti-guerrilla operations. Second, advanced detection gear designed for such purposes is generally conspicuous by its absence from the T. O. & E. of U.S. military units and is not to be found at all in Southeast Asian military services. Third, such U.S. gear as exists may not be usable in the SE Asian theater, or by indigenous troops. In the study, a number of requirements have been suggested and certain new methods offered to satisfy them. In every case, some test work was found

~~SECRET~~

to be required and in most instances the basic data needed to establish feasibility were not available.

The motivations for the constraints were, respectively, a restricted mission, or anticipated difficulties, political or otherwise, in utilizing certain techniques; and a desire to avoid duplicating other studies. The practical results of the constraints have been as follows: Certain obviously promising solutions to accepted requirements have not been treated (e.g., the use of polygraph techniques to determine whether particular villages harbor guerillas); methods of surveillance and reconnaissance in common military and civil use have been examined, if at all, only cursorily for applicability to this problem (e.g., aerial photo-reconnaissance and associated monitoring techniques have not been treated); and, no broad and systematic analysis of the entire conflict has been undertaken (i.e., the requirements have been constructed solely on the basis of historical experience, a partial appreciation of the conflict, and common sense rules).

This final report is formulated as follows: The body of the report, Sections 1 through 4, consist of a relatively concise account of the substance and findings of the study. Details of the work, substantiating data, and other information of interest are given in Sections 6 through 10, which are Appendices. The Appendices are large as all the pertinent material gathered in the study is included on the basis that it may be useful in future work. References to the literature and the Appendices are carried in the body of the report, and figures are collected at the ends of sections or subsections. Section 5 provides a general bibliography.

SECRET

The study was organized on the basis (1) that the current conflict in South Vietnam might not be resolved for years; (2) that guerrilla operations in the same general pattern might spread to other parts of SE Asia; and (3) that techniques of general applicability (i.e., generally applicable to wet lands, jungles, forested uplands, mountain areas, etc.) would be of greatest interest. Thus, while near-term solutions to Vietnam problems were considered to be important, the study contemplated potential long-term applications as well. Requirements and solutions applicable to the various parts of all of SE Asia were sought. For these reasons two areas, assumed to be of major interest, were examined. South Vietnam, where a favorable effect on the current conflict might be obtained, and Thailand, potentially an area of conflict. Thailand moreover may be thought of as a laboratory reasonably representative, because of its diverse features, of all SE Asia, and much of South Asia. For convenience, an outline political map of SE Asia is given in Figure 1.1.

In a conventional attack on this problem one might make detailed surveys of the state-of-the-art in surveillance and reconnaissance, including extrapolations, and of the natural backgrounds of pertinent phenomena in the conflict areas, and relate these to operational needs. Instead, the following approach was employed: first, a preliminary survey of operations and environmental factors was made to indicate some requirements and suggest promising techniques. [A first-hand report was provided by B. Alexander, from a survey trip undertaken in March and April of 1962.] The relatively few generally promising and previously unexploited ideas which emerged from this survey were then examined in some detail, and carried to the stage of recommending

~~SECRET~~

test and research programs. Thus, as it happened, most of the effort of the study was expended on specialized problems of infrared surveillance, including some simple experiments. Much of the time remaining was allocated primarily to investigating a variety of techniques, with priority given to those which, on balance, considering feasibility, operational utility, availability, and simplicity, seemed most promising.

This method of approach was chosen as being most likely, in a short study, to produce immediately useful results.

During the course of the study, Project Agile was organized into several sub-projects including Project V - Combat Surveillance and Target Acquisition Systems, which assumed responsibility for Contract DD-126. Since a major element of this project involved environmental research, some additional effort was devoted to gaining a greater understanding of the importance of environmental factors and practical constraints on operational needs.

The technical findings of this particular study are summarized below. Details of the depth of the study relevant to the findings are given in the text:

1. No military detection method was found which promises an over-all, overwhelming advantage for government forces.
2. Two previously unexploited applications of infrared thermal-mapping techniques may offer substantial advantages to government forces.

They are:

- a) Wake-mapping of submerged lands, and
- b) Detection of fires under forest cover.

Exploitation of both techniques rests on acquiring basic data not now

~~SECRET~~

~~SECRET~~

in hand. The results of experiments to date are not fully understood and additional experiments and field tests are needed. Insofar as existing equipments are technically feasible for the suggested applications, which is marginal, they are not generally suitable for use by indigenous forces. The fullest exploitation of the phenomena, as now understood, would require the development of new equipment. New equipment for optimizing fire detection, on geometrical grounds, is suggested.

3. With respect to passive infrared equipment used at short ranges, reported field tests have been mostly unfavorable. Additional work is needed on requirements and the specification of design parameters.

4. With respect to radar;

a) Aircraft radar surveillance to detect armed personnel concealed under forest cover, or moving under cover, does not look particularly promising. The present state of knowledge of typical signal-to-noise conditions is, however, insufficient to settle the question. Enough uncertainty exists that basic experiments are needed and are justifiable.

b) Short-range detection of moving personnel is certainly technically feasible in certain situations. The operational utility of existing or advanced equipment is not resolved. Additional studies are needed.

c) The use of specialized radar and associated equipment to locate the source of small arms, heavy rifle, and mortar fire from the

~~SECRET~~

ground, helicopter, or aircraft with sufficient precision for return fire, may be feasible and should be investigated.

5. Acoustic listening devices for monitoring trails and areas, and for detecting or ranging on groups attacking strategic villages are technically feasible. In many cases, suitable gear can be simply constructed using native materials. There is, generally, poor information on typical signal-to-noise for various situations and advantages over other methods are not known. Operational feasibility for many potential applications is questioned (e.g., in trail monitoring because of the allegedly vast numbers of trails, and the supposedly enormous data-handling problems.) Additional studies are needed.

6. Geophysical prospecting methods may be of some interest in specialized applications (e.g., sensitive magnetometers to aid in surface inspection of limited areas for concealed arms) Further work is required.

7. A variety of exotic "cooperative" ideas involving preferential tagging of guerrillas by chemicals do not, on balance, seem promising.

8. In general, environmental data, particularly those relating to natural backgrounds of phenomena employed in surveillance, are sparse. There is substantial evidence, based on other considerations, that local (i.e., U.S. and Latin-American) areas selected for field tests are not representative of SE Asian conditions. An effort to obtain extensive detailed data on certain classes of SE Asian backgrounds would be very worthwhile.

Experience gained in this study has led the Contractor to certain nontechnical conclusions, pertinent to future work in this area, which are, therefore,

given below.

9. State of the art, development, and research in surveillance are widely different in the various Services and other U.S. agencies. Knowledge is shared slowly, at present, and specialized tricks of the trade filter from their origin to other Services and ARPA in rather leisurely fashion. A vigorous across-the-board review of surveillance in counter-insurgency, on the style of the well-known technical reviews of missile defense problems would be helpful. Existing programs could be criticized and gaps made evident, areas of agreement and disagreement could be outlined, and key issues pinpointed. It is not too much to hope that an agreed upon over-all program could be formulated.

10. Although the ARPA role and mission under Project Agile has become increasingly clear, the emphasis on research for long-term objectives, as contrasted to gadgeteering for immediate application, has not been made clear. There is some confusion in industry quarters concerning the various Service missions and their relationship to the ARPA mission and, in particular, to the role of research.

11. Under the present program, it seems that essential long-term research may be de-emphasized in favor of special projects designed to give short-term relief in Vietnam.

12. Although fairly narrowly defined studies such as the one reported here may be productive, there is a strong possibility that (a) substantially greater rate of progress would be obtained with an effort large enough to sustain a multidisciplinary approach (i.e., at least one-half dozen specialists); (b) experience and data are obtained slowly enough

[REDACTED]

that it would be most worthwhile to maintain any particular effort for at least a few years.

13. Finally, it is apparent that quite diverse views exist on how best to employ advanced technology in counter-insurgency operations. This problem of requirements cannot be stated in ways which are generally acceptable to all workers in the field. This diversity of opinion might be reduced by a series of discussions on actual experiences in recent military operations in Vietnam and by detailed reports of operational encounters and results.

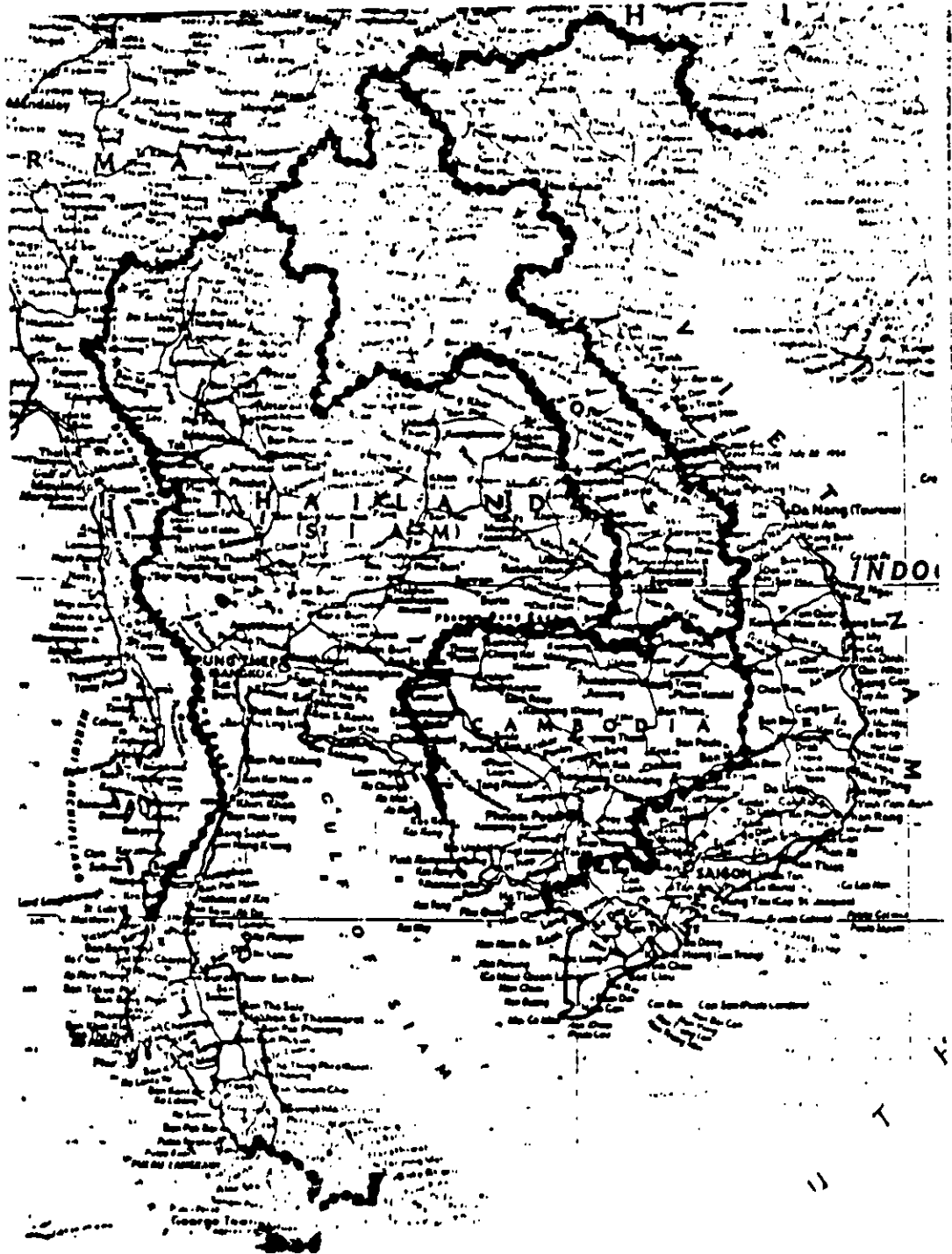

POLITICAL MAP SOUTHEAST ASIA NEIGH. AREAS

~~SECRET~~

SECTION 2

REQUIREMENTS

2.1. General

The term - requirements - is used here to encompass the needs and desires of the military services for detection and surveillance capabilities. These are for operationally feasible and attractive means to detect guerrillas, their movements, stores, bases, and operations in the regions in which they operate, or may operate in the future. Feasibility, in this sense, means the methods must work consistently, and be useful under conflict conditions and, eventually, be usable by indigenous troops. To be attractive, the methods must significantly enhance the probability of successfully attacking guerrillas, or definitely hamper their operations.

Two factors are of primary importance. First, it is necessary to know as quantitatively as possible, what difficulties are imposed by the environment (e.g., terrain, vegetation, climate, etc.) of the conflict and what special opportunities are afforded. Second, since the nature of conflict operations may strongly affect requirements, operational factors must be considered with some care. The former consideration is discussed briefly in 2.2, and later in 2.3 following. Both are treated in greater detail in Section 6.

Guerrilla warfare in South Vietnam follows the traditional patterns of early conflict established in China, North Vietnam, the Philippines, Malaya, and Laos, modified initially by the character of the country and the accessibility of sanctuary and more recently by U. S. - introduced operations.

-2.1-

~~SECRET~~

~~SECRET~~

Guerillas now operate in all parts of S. Vietnam, in small teams, platoons (30 men), and companies (90 men). Occasionally forays in battalion strength, or engagements presumably involving larger forces are reported. Some 500 terror incidents per month are alleged to occur, involving virtually all of South Vietnam, including sabotage, arson, kidnapping, assassination, ambush, and attacks on outposts and communities. Some of the major incidents and conflicts publicly reported in the last year by U. S. correspondents are shown by the crossed circles in Figure 2.1.1.

It is believed that there are on the order of 25,000 Viet Cong organized regulars and possibly 75,000 - 200,000 irregulars and VC village defense forces. Many areas are more or less completely under VC control. Although, as in previous guerilla campaigns in their early stages, the government keeps many more men under arms than there are guerilla regulars (perhaps a factor of 10, or more) it is very difficult to bring this numerical superiority to bear. Great difficulties are experienced in reaching the scene of attack in time to engage guerillas, in tracking and closing with insurgents after terror incidents, in dealing successfully with ambushes, in locating bases, in detecting infiltration from extra territorial sanctuaries, and in disrupting supply and communications lines to adherents and passive supporters.

These difficulties arise from a large number of causes; including poor communications, and transportation problems. It is generally felt by observers on the scene that the difficulties could be greatly alleviated by better detection techniques. On the basis of experience in guerilla conflicts already concluded, and current experience in Vietnam, a reasonable set of general requirements can be given, bearing in mind the general

~~SECRET~~

~~SECRET~~

problems of feasibility and attractiveness, and the constraints discussed earlier. Such a list is given in Table 2.1.1 below:

Table 2.1.1 General Requirements for Military Detection

Primary Purpose - Future Attack

1. Location of guerilla bases.
2. Identification of favored routes into and out of bases, internal sanctuaries, and extra-territorial sanctuaries.
3. Identification of lines of communication and supply to supporters.
4. Location of stores and hideaways away from bases.

Primary Purpose - Immediate Attack or Defense

5. Warning of ambushes.
6. Rapid and precise location of ambushing forces and quick reaction.
7. Warning of, and precise detection of guerillas moving to or from ambush or attack of outposts, communities, or other fixed sites.
8. Precise location of attacking forces and weapons.
9. Tracking, or real time detection of guerilla movement under cover of darkness or natural concealment.
10. Location of guerillas in temporary concealment (as in brush, burrows, or under water).
11. Rapid, precise location of weapons firing on aircraft.

~~SECRET~~

In general, it is presumed that, other things being equal, detection techniques which work at long range (e.g., from aircraft) would be preferred, and real time data-handling would be favored over methods which are only useful for future attack. Next most desirable would be short-range real time methods usable by combat elements and convoy escorts. Fixed, short-range, line or area surveillance devices would be of lesser interest.

In this study, methods are suggested which may, if feasible, partially satisfy Requirements 1, 2, 4, 6, 7,8,9,and 11. Estimates of the feasibility of meeting such requirements and criteria are discussed at appropriate points in the body of the text. In general, the question of feasibility rests on fundamental data not yet in hand and for which, in most cases, no programs exist.

The subsections following summarize briefly the environmental and operational factors of importance covered in detail in Section 6.

2.2. Environmental Factors

The Viet Cong have major bases at many points in South Vietnam and, of course, infiltration may occur along almost all of the nearly 1000 miles of border with North Vietnam, Laos, and Cambodia. Some major bases reported publicly are in An Xuyen province on the Camau peninsula, in the provinces along the Cambodian border, such as Tay Ninh, along the Annamite mountains opposite Da Nang and Hué, and in Zone D, some 40 miles northeast of Saigon, which occupies most of Phuoc Thanh province. These, and some other provinces, are sketched crudely in Figure 2.1.1. They are mentioned to illustrate the variety of conditions under which guerillas must be detected.

~~SECRET~~

~~SECRET~~

An Xuyen is a marshy delta, replete with mangrove swamps; Tay Ninh is a rice area, and other nearby provinces contain much paddy land; opposite Da Nang and below, at the terminus of the Ho Chi Minh trail, are heavily forested, precipitous mountains and narrow valleys; Zone D is mostly hilly with dense jungle covering; inland from Binh Dinh, and from much of the eastern and southeastern coastal strip below are regions some tens of miles deep covered with primary rain forest.

Means must be found to detect guerillas in a variety of forests, including dry upland, monsoon, and tropical rain forests, in tropical swamps and marshes, and in generally wet lands such as rice paddies and river deltas. The major difficulty in assessing the feasibility of various schemes is that quantitative data on the environments are not available.

Should Thailand become an area of major conflict, various regions pose similar environmental problems.

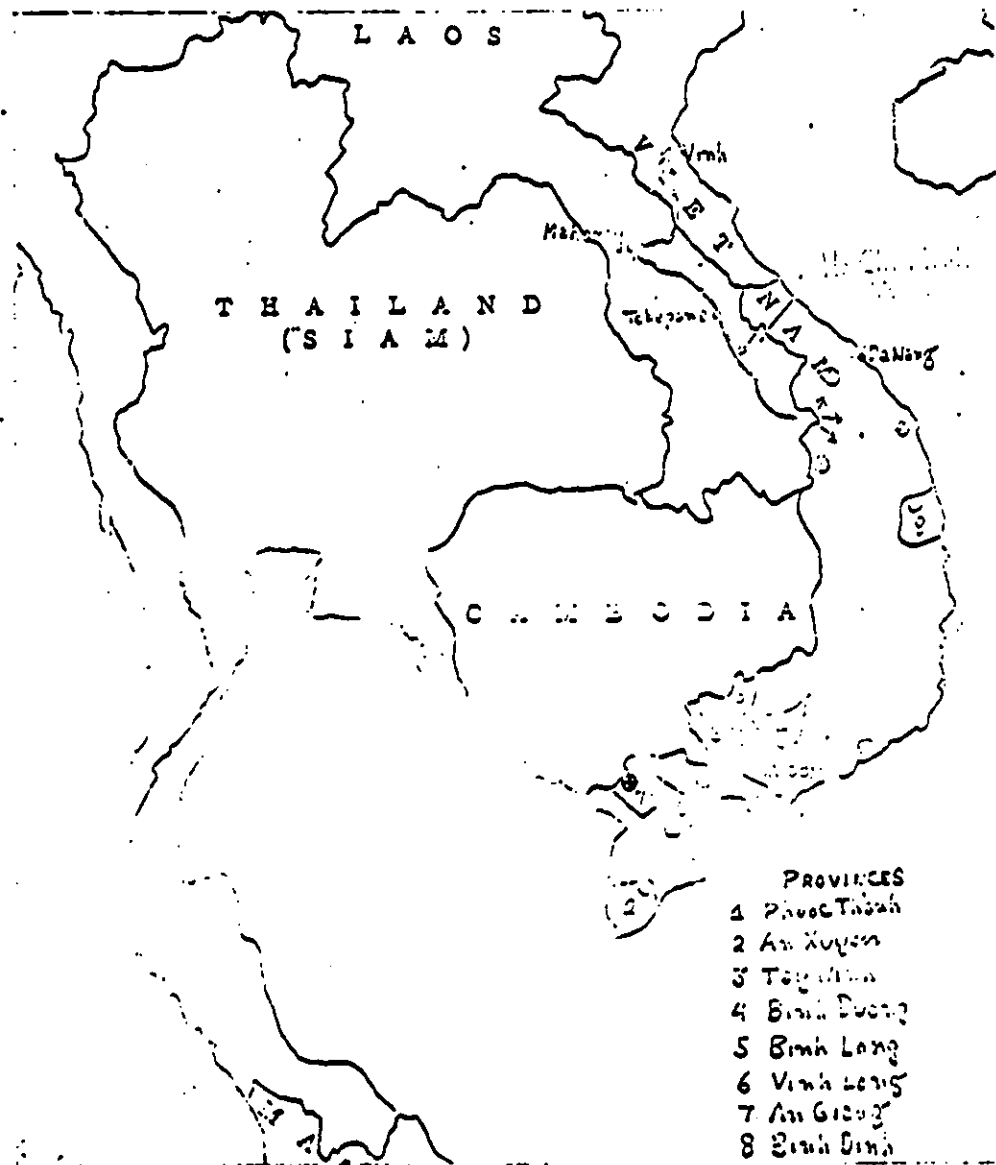

FIGURE 2.3.1 SOME MAJOR AREAS OF CONFLICT - S. VIETNAM

~~SECRET~~

2.3. Operational Considerations

There are not many "engineering" texts on guerrilla warfare. Accounts of historical experience do not, usually, recount success and failure points of tactical operations in ways that are useful for deducing appropriate corrective action. Statistics in detail on current operations have not been available. Some few accounts, which are quoted at length in Section 6, do give valuable insights into operational necessities.

With respect to advanced detection devices, none seem to have been employed in Malaya, in French Indochina, or the Philippines, except that in Malaya the British tried both military dogs as trackers (unsuccessfully) and imported native trackers (successfully).

The lessons on jungle warfare are explicit. Patrol economy requires that any detection devices carried be as light and as rugged as possible. Presumably the advantages attributed to them must be very substantial or they will not be used in any case. The most successful technique reported in an account of Malayan operations was the intelligent deduction, by a great number of observations on the ground, of routes favored by the CT's in their travels to and from hidden jungle bases.

In Vietnam similar and more extensive difficulties are encountered and the environment is more varied. There are a factor of 3 or so more VC's now active in Vietnam than were ever active in Malaya and a smaller percentage of territory is under government control. The terrain is somewhat more rugged and, since the fighting element consists of Vietnamese troops the rapid inclusion of new (Western) methods is not easily obtained. There are still major VC bases in the jungles of Vietnam which cannot be (precisely) located.

~~SECRET~~

~~SECRET~~

Operations in flooded lands are fairly common. Travel across territorial boundaries is not controlled. Since enemy unit sizes in forays is difficult to estimate, government forces (patrols) are sometimes overmatched and as frequently, government units of unnecessarily large size are employed. Traps, snares, and spikes are commonly employed on trails and likely helicopter landing points. Ambush is frequent and devastating. The local populace is, at best, primarily passive and does not report VC movements or preparations.

An operational factor typical to all guerrilla conflicts at some stage is the extremely unfavorable ratio of government troops to insurgents. It may be observed that the preponderance of such troops always are engaged in guard and civil control or are held in reserve. The widespread adoption of intrusion detection devices and general mechanization of such duties may conceivably, make possible a reduction in control-troop strength.

The ratio of combat troops to active insurgents is not nearly so large, and probably cannot reasonably be reduced. Advanced detection devices, however, may enable these troops to operate more efficiently and to sustain a higher level of pressure on the enemy. Major operational hazards are uncontrolled access to extraterritorial sanctuaries, and the existence of stable, unapproachable, VC bases and training centers, and freedom of movement of guerrillas. Advanced detection devices may alleviate these hazards.

~~SECRET~~

~~SECRET~~

SECTION 3

METHODS

3.1 Introduction

A variety of novel and familiar detection methods are briefly discussed in this section. Emphasis is on satisfying presumed requirements for anti-guerilla operations in Southeast Asia. Reference is made to known programs and experience is cited. The objectives and constraints previously discussed are implicit in the ideas treated.

Since extensive surveys were not possible under this contract, only a few data on military service detection programs and industry proposals are presented and these are scattered throughout the report. Pertinent ARPA field programs (or stated requirements) as reported from the CDTCs in Vietnam and Thailand (Refs. 3.1-3.4) are listed in Table 3.1.1. In the Table, and throughout the report, methods of detection have been divided into two general classes; observational, in which detection is achieved by observing target signals against the natural environment; and cooperative, in which detection is achieved because the characteristics of the target, or of the natural environment have been purposefully altered.

-
- 3.1 Periodic Report, CDTC, RVNAF (1-31 July 1962) Sec.
 - 3.2 Letter Report, CDTC (Thailand) (1-30 Sept. 1962) Sec.
 - 3.3 Letter Report, CDTC (Thailand) (1-31 August 1962) Sec.
 - 3.4 Letter Report, CDTC (Thailand) (1-30 Sept. 1962) Sec.

~~SECRET~~

SECRET

Table 3.1.1 Existing Guerilla Detection Programs

Observational Detection

<u>Program or Requirement</u>	<u>Short Comment</u>
Mapping and aerial reconnaissance	In delta operations--type unknown
Environmental & operations research (Ref. 3,4)	Thailand--heat sources and surveillance problems
Mine detector for nail-board detection	Nail-field clearing program
Doppler surveillance radar	Test of AN/AP3-4 & newer models
Airborne surveillance for weapons and ammunition	Geophysical techniques (requirement)
Border surveillance (fences, mines, radar)	Research on control methods
Active and passive short range IR	Tests of existing night viewing gear and requirement
Seismic device	NOTS-geophone-high sensitivity
Directional microphone	Thailand-tests of Bangkok microphone
Railroad security (rail breaks, mines, etc)	Requirement--electronic methods
Military dogs	Patrolling, warning, tracking, aggression

Cooperative Detection

<u>Program or Requirement</u>	<u>Short Comment</u>
Village alarm system	Coded pulse radio signal
Chaff rockets for out posts	For AF radar net observation-- 4-4 oz chaff to 2000 feet
Target marking device	For marking drop points, etc.
VC Stain grenades	Persistent stain for later UV examination
TIARA	Chemiluminescent persistent compound
Vegetation killer	Denude natural cover

~~SECRET~~

The AGILE CS&IA program, as reported in Ref. 3.3, lists in addition a specific program on persistent sounds, a basic data experiment on the feasibility of aerial radar surveillance to locate concealed personnel (with Conductron Corp.) and a program on fire detection (originally suggested by the Contractor.) Also listed is a general program of investigation in

Acoustic & seismic devices;

Passive and active IR;

Radar and other electromagnetic detection;

Passive & active optical viewing, image intensification, etc.

and a requirement for environmental research on related phenomena.

Infrared (3.2), radar (3.3), and acoustics and geophysics (3.4) applications are treated briefly in this section and in detail in the Appendices. The treatment in both places is somewhat uneven since the study effort was concentrated on the most promising and potentially useful ideas that came early. These happened to be primarily in the infrared field.

Without exception the tactical utility of the methods cannot be established without some testing. In the most interesting cases fundamental measurements or extensive field testing are required to establish operational feasibility and to fully exploit the techniques. Equipments suitable for use by indigenous troops must be developed.

3.2 Optical

The observational optical methods of most promise suggested in this

3.3 Quarterly Agile Report. 1 July - 30 Sept. 1962. Confidential.

~~SECRET~~

3.3

study both involve the employment of high resolution thermal mappers. Two of these may result in generally applicable techniques; one for use against guerillas in forest and jungle, the other in flooded lands, swamps, etc. These are a) personnel wake detection, and b) fire detection.

a) Wake detection: It is reasonable to suppose that movements of moderate to large guerilla forces to points of assembly in paddy lands may be primarily at night, if the region is under any kind of surveillance. Preliminary calculations on probable temperatures alone, indicate that personnel moving through stagnant bodies of water may leave "wakes" similar to ship wakes, of sufficient persistence to be useful, if detectable, in establishing patterns of movement. Existing thermal mappers may have high enough resolution and sensitivity to map such wakes. The indications could also aid in the tracking of guerillas in flight, in monitoring swamps, and in other surveillance operations in flooded lands. The capability may also be applied to the control of guerilla water traffic, in locating submerged bridges, etc.

At the present time the existence of the phenomenon has not been demonstrated (only one test, under rather unfavorable conditions [see 3.6] has been run, with negative results) and, of course, the intensity, extent, and duration of such a phenomenon under varying environmental conditions are completely unknown. [On the other hand ship wakes, temperature gradients in water, and a variety of other surface phenomena have been recorded by thermal mappers observing the apparent temperature (temperature/emissivity product) of a thin surface water layer.] Basic data on the

~~SECRET~~

~~SECRET~~ ~~SECRET~~

phenomena are needed- to establish the technical feasibility and results of personnel wake surveillance and to determine whether existing mappers are adequate or whether new equipment would be needed.

The question of operational utility is complex and not easily resolved. Logical arguments for, and against, the method being of tactical value have been constructed. In the Contractor's view, this question is raised prematurely since the products of such surveillance cannot be described at this time. An essential experimental program (see 4.1) was recommended early in the study but has not been undertaken.

- b) Fire Detection: Guerillas living in forests and jungles, especially in mountain areas are reasonably expected to use campfires. In any case, since rice is a staple of the diet there must be cooking. Early in the project it was suggested that the detection of such heat sources under dense canopy should be technically feasible. Preliminary calculations (and subsequent experience) showed that existing thermal mappers would detect open fires and hot spots if a direct line of sight between mapper and source could be established. There is also some possibility that detection may be achieved on glint (i.e., scattering) without direct lines of sight.

It may be argued, reasonably, that area mapping of jungle resulting in the detection of small fires might help to pinpoint VC base locations which were not otherwise observable. With reliable and precise detection it is even possible that hunter/killer missions may become feasible.

As soon as this idea was suggested by the Contractor plans were made by ARPA for a piggy-back experiment in Operation Tropicana to settle the major question of performance against the type of dense canopy that occurs in the rain forests of SE Asia.

Not much is yet known about the actual density of openings in rain forest and in particular the nature of coverage provided by forests in SE Asia is not quantitatively known to any degree. One thing is clear; if detection is achieved by solely direct looking (i.e., a direct line of sight between scanner and heat source through the canopy) present thermal mappers, which are line scanners, provide an unnecessarily low probability of detection in reasonable missions, as each element of the target field is examined only once. An order-of-magnitude (roughly) higher probability of detection can be provided by an easily constructed scanner of simple design which looks several times, from different angles, at each element of the target field.

It may be argued that, for tactical use, considering the unknown incidence of false alarms, etc., it would be desirable to establish fire patterns. That is, in a mission, to see some fraction of all the fires present in a mapped area. On this basis a tactical scanner should provide a high probability of seeing at least some (selected) fraction of all targets in any given mission. Since this probability is a function of the number of targets, the canopy density, and the number of tries, performance predictions must be founded on statistically planned tests, which have not as yet been carried out. Further, as in the wake case, sufficient data

~~SECRET~~

on background effects and fluctuations, and on the statistics of operational environments are not available.

The question of operational utility is, again, complex. Surely, if one major base were so located and successfully attacked, a reasonable effort would be justified. As a continued surveillance tool, utility depends on security (i.e., countermeasures are relatively simple), high reliability and a high probability of detection per mission.

An extensive field test program, planned to obtain statistically valid data is needed, and the development of an optimally designed scanner should be considered. (See 4.3).

The feasibility of another application of potential value depends on unknown environmental conditions as follows: If canopy-hidden roads, streams, and trails, or corridors (bands) of lower ground foliage density, provide canopy surface thermal gradients which are detectable above background, thermal maps may provide an indication of favored routes of travel. The basic argument is that, as in the case of streams, a substantial difference in structure under the canopy, with no second or third canopy from smaller trees, and little if any ground cover, would exist, producing a different heat cycle and at least an out-of-phase equilibrium-temperature cycle. Thermal maps and temperature data on a variety of forested areas containing such artifacts are needed to resolve this question.

One cooperative method using thermal reconnaissance suggests itself. For example, if mountain tribes could be induced to give warning of infiltration by lighting fires in an unusual pattern, or number, or location, the thermal mapper could be employed for border or area surveillance. Such

SECRET

warnings might be continued at low risk to the tribal peoples and could be useful for a long period. If tribal peoples are not helpful or correctly located, strategically placed Vietnamese observers could be employed.

The more familiar, short-range applications of optical devices in battlefield and approach surveillance, ambushing, and guard, and as weapon sights have been examined. Existing equipment is generally unsatisfactory for SE Asian anti-guerrilla operations. What is needed, since the state-of-the-art is well known and reasonably predictable for the near future, are carefully constructed requirements, fortified by suitable background measurements.

SECRET

3.8

3.3. Radar

Reflection on current military radar programs produced few ideas for promising new guerrilla detection methods. The feasibility of a method proposed by Gouduetron (involving an aerial surveillance radar to detect armed personnel in dense forest), depended on a variety of unknown propagation factors. A set of basic experiments to resolve these were suggested.

One interesting possibility which has not been very carefully examined, is that of constructing a pulse-modulated doppler radar with high clutter rejection, for use as an anti-ambush device. The argument is as follows: One commonly accepted requirement in ambush situations is that of returning ambush fire as quickly and accurately as possible. This is sometimes very difficult as the attack is controlled, sudden, and the attacking weapons are hidden in natural cover. It is conceivable that a short-range radar could be built which would rapidly and precisely locate sources of fire from trajectory data on small arms and automatic weapon fire. Possible characteristics of such a radar are given in Section 8. Although data-processing problems have not been examined it seems possible to couple this indication to a suitable fire detector. The advantages (in reaction time, etc.) have not been examined. The same radar might be provided, also, with a mortar shell trajectory determining mode.

A radar with these features might also be adapted to helicopters and, with some modification, to low-flying aircraft.

While no very positive statements can be made about the feasibility and value of this type of device, it appears that the idea deserves further examination.

Radar mapping to determine favored routes, trails, etc., would be interesting, if feasible. As in the similar IR application of 3.2, and the PASS suggestion, this possibility rests on unknown propagation, background, and environmental factors.

Such anti-personnel and battlefield surveillance radars as could be studied do not seem particularly useful in the operational context of S.E. Asia.

3.4. Acoustical & Geophysical

Acoustic and seismic devices have been suggested for use as line and area monitors, intrusion detectors and in jungle tracking. Considering the first two uses, the primary problem is that of generating valid requirements, specifying types of operation desired, and obtaining sufficient data on target signal/background relationships to justify design specifications. Other than operational and environmental unknowns there are not substantial research questions. An interesting decision problem is whether to try to utilize native materials in the construction of low frequency acoustic collectors or to rely on the acoustics/electronics art as developed in the U.S. A number of ideas have been examined and discarded for using acoustic instruments in jungle tracking or by patrols in general.

Magnetic detection of stored arms, burrows, or armed personnel is, at best, just marginally feasible. Presuming a valid requirement for this type of on-site inspection, it will be necessary to make some simple tests to establish performance and value of a few portable instruments.

3.5. Other

A few non-classifiable suggestions have been made. Generally, these have not been analyzed but are offered below in the cause of completeness. For

SECRET

example, related to border surveillance problems, examination of the topography of the region at the terminus to the Ho Chi Minh trail and northward, reveals an extremely rugged terrain. It seems unlikely that there can be a great many easy routes of access. Possibly, control of only a relatively small fraction of the border in this area, at critical points, would greatly increase the difficulty of guerilla infiltration.

Application of acoustic or seismic devices to trail-monitoring is not favorable because of the great lengths of trail and associated logistics, cost, and data-handling problems. It has been suggested that necessary wire laying be done by aircraft, onto the tree tops. If, as discussed in Section 6, most mountain area jungle trails lie along ridge tops, plane wire-laying and acoustic surveillance of some trails might become economically feasible.

Considering the use of seismic devices three possibilities are suggested. These are; a) a seismic village alarm by detonation of buried explosives; b) detection of burrows by explosive sounding techniques, and c) canal monitoring by geophone.

The use of contrast photography to monitor the success of crop-killing campaigns seems reasonable; and the possibilities of development of special data-processing equipment for thermal mappers (e.g., to produce temperature-contour maps from thermal scanning) is an interesting area for exploration.

3.6. Experience

During the study field experience with IR equipment was examined in some detail and is reported in Section 7. Available reports of tests of military surveillance gear were scanned and are discussed under appropriate headings.

~~SECRET~~

In addition, Defense Research Corporation participated in a "quick-fix" experiment on personnel-wake detection, and had an observer in Operation Tropicana. Furthermore, simple instrumentation for a limited-range environmental measurement (temperature cycles, bottom conditions, vegetation, etc.) by CDTC (Thailand) on paddy and klong characteristics, was assembled and shipped together with brief plans for typical measurements. Prior to the delivery, as a quick check-out of the temperature measurement instrumentation, the diurnal variation of the vertical temperature--distribution in about 10' deep fresh water was measured. In contrast to the predictions of the early calculation (7.4.1.2) these check-out measurements showed a maximum temperature excursion, throughout the depth below about 1/8" from the surface, of about 1°F around the noon hours and, hardly measurable (~ 0.1°F) excursions during the rest of the day.

As was pointed out in the brief plans, and in plans for basic-data experiments (Section 7.4.2); the thermal radiation characteristics of water are determined by the radiative properties of a thin surface-film; (i.e., its temperature and emissivity). The apparent absence of a relatively large temperature-excursion in depth should not be regarded as conclusive evidence of the absence of detectable personnel-wakes*.

* As this report is being printed, information from CDTC (Thailand) on preliminary klong temperature measurements have been received, that seem to confirm the check-out measurements.

~~SECRET~~
3.12

STUDY AND RESEARCH

Section 3. above, contains a resume of detection methods and techniques suggested for possible application to anti-guerrilla operations in S. E. Asia. This section provides a concise listing of studies, research and test activities to provide the data necessary for estimating feasibility and operational value of the suggested applications.

4.1. Fire Detection

The Contractor has very serious doubts that existing line-scanning thermal mappers used for observational detection of fires will be tactically useful against very dense canopies. Current experimental results, if verbal reports are correct, are not fully understood. It is suggested that the following type of program is needed:

For direct detection

- o A collection program for photographic and illumination data on the variety of S. E. Asian forests, to arrive at cover density and distribution ranges.
- o A statistical analysis defining requirements for statistically meaningful fire-detection field tests considering widely varying canopy densities, single- and multiple-look scanning.
- o An examination of the tactical advantages of a thermal mapper which looks several times at each element of the target field from different look angles, and consideration of the short-term procurement of a suitable test item.

For indirect detection and natural gradient measurements

- o A program to collect data on temperature radiance, and reflectivity (and their fluctuations) of the "top surface" of a well known dense-

SECRET

to very dense canopy under varying natural conditions. A cliff-top-to-jungle static experiment would be preferred. Data on multiple scattering would be obtained by off-angle measurements of illumination due to a movable collimated source beneath the canopies. The experiment should include an attempt to measure surface gradients due to (1) an underlying heat source, and (2) underlying discontinuities such as streams, roads, and trails.

For cooperative detection

- o A study of the feasibility and operational value of surveillance for cooperative fires (beacons) in border control and similar activities.

4.2. Wade Detection

The Contractor believes that detection of personnel movements in flooded lands, by aerial IR mapping may be feasible and of operational value. The following type of program is recommended:

- o A basic measurements experiment to establish the extent, intensity, and duration of predicted phenomena. The experiment suggested is simple and direct. Time-period, point-by-point radiometer mappings of the surface of a controlled pool would be made. The effects of controlled reproducible disturbances, similar to those made by wading personnel, on the apparent temperature of the surface would be determined. The effects of a variety of bottom materials and natural growth, similar to those encountered in S.E. Asian flooded lands, would be measured. Water conditions, climatic, and meteorological variables would be recorded and their effects assessed.

SECRET

- o Concurrently with this experiment, if obtainable at negligible cost, maps of recently disturbed natural pools would be obtained, using the best ship-wake mapping techniques. These tests, while not conclusive, would build up a valuable catalog of field experience in such observations.

4.3. Radar Surveillance

With respect to radar surveillance potentialities the following type of program is suggested:

- o Propagation and cross-section experiments necessary for determining the feasibility of PASS.
- o A study of the feasibility of pulse-modulated doppler "anti-ambush" radar and fire-control, including mortar-location modification, adaption to helicopters, and probability of application to pertinent winged aircraft. A companion study of operational factors to determine anti-ambush and defense requirements for systems of this type.
- o A study of the feasibility and payoffs of long-wavelength radar mapping of forested areas, and planning of critical experiments.
- o A field study to determine valid requirements, if any, for anti-personnel radar in S.E. Asia. Planning of experiments to collect essential data.

4.4. Listening and Magnetic Detection

Studies under this contract indicate that (1) the state-of-the-art in sensitive acoustic and seismic devices and associated electronics is such that any reasonable instrument specifications can be quickly met and performance

~~SECRET~~

predicted accurately; (2) certain types of sound collectors would be built with native materials, but S.E. As'an capability for associated electronics falls far below U.S. standards; (3) performance of selected instrumentation is highly dependent on background; (4) overall surveillance capability in a particular application depends strongly on the mode of surveillance selected; (5) widely different modes of surveillance may be needed in different applications, target signal behavior is poorly known, and backgrounds have not been measured. On the basis of these findings the program preferred would run as given below:

- o A field study to define requirements, if any, for listening (acoustic and seismic) surveillance devices in terms of type of surveillance, details of mode of operation, operational factors such as siting, personnel, maintenance capability, etc., and environmental conditions.
- o A following field study to, if necessary, collect required data on local noise environments, target characteristics and other necessary environmental data.
- o A companion study to define specifications for equipment to meet requirements, and recommend U.S. or local sources for equipment.
- o Necessary test and evaluation programs.

With respect to magnetic detection:

- o A brief survey to establish the validity of suggested requirements and simple field tests of geophysical prospecting equipment to establish the correspondence between requirements and obtainable detection ranges.
- o If necessary, thereafter, field measurements of magnetic anomalies and temporal fluctuations in the Far East.

SECRET

4.5. Summary and General Comments

On the basis of study of requirements, applicability of existing equipment and experience, and potential applications of new methods, a set of specific study and research programs have been suggested. These are in the fields of infrared, radar, acoustics, and geophysics. Some of the other requirement/solution combinations which suggest themselves cannot be evaluated well enough from available data to justify firm recommendations.

It is the Contractor's feeling that a broad but quite detailed systems analysis of the conflict, oriented towards defining specific detection, surveillance, and reconnaissance requirements, and carried out largely in the field, is needed to achieve significantly more progress in this area. Experience with operational factors, and detailed data on operational statistics and environmental conditions are essential inputs to such a study.

An example of this need is illustrated by the lack of detailed requirements for surveillance and intrusion detection gear for protecting outposts and strategic hamlets. It is not known whether visual observation is sufficient or whether detection devices would have a definite payoff. The relative advantages of acoustic, infrared, or radar for these purposes are unknown, and the influence of operational, environmental, and civil factors has not been explored.

4.5

SECRET

BIBLIOGRAPHY

This section provides a useful bibliography on guerrilla warfare philosophy, strategy, tactics and operations. Other items of general interest are included. Most of the sources noted were consulted by the Contractor but the bibliography does not repeat the many references cited in the body of the text and the appendices. This accounts for the paucity of technical sources. A greater number of sources were consulted in the course of the contract but were purposely omitted from the bibliography on the grounds that they were of no value whatever.

5.1. Philosophy, Strategy and General Tactics5.1.1. Classics

Giap, Ho Gueyn. The Great Experience of Our Party in the Leadership of Armed Struggle and the Building of Revolutionary Forces (Hanoi)

Griffith, S.B. Ma Tse Tung on Guerrilla Warfare N.Y. Praeger 1961

Guevara, Che. Guerrilla Warfare MR Press, N.Y. 1961

Hastings, D. Partisan Warfare Zürich, 1960

Lawrence, T.E. Seven Pillars of Wisdom Doubleday 1938

Ma Tse-Tung. Selected Works N.Y. International Publishers

Peterson, H.C. Che Guevara on Guerrilla Warfare N.Y. Praeger 1961

Shan Viscount. Defeat into Victory N.Y. David McKay 1961

Partisan Operations Field Service Regulations, Red Army 1944 Chapter XVII

Manual on Anti-Guerrilla Warfare (Viet Minh Manual, Bulletin Militaire Dec. 1957 (L'École d'Application de l'Infanterie de Saint-Maixent)

5.1.2. Other General Studies

Chen, F. The Jungle is Neutral N.Y. Norton, 1949 (Chinese Communist guerrilla training, organization, etc.)

Chiu, S. M. Chinese Communist Revolutionary Strategy Princeton, Center for International Studies, Research Monograph, forthcoming, c.\$1.00

Dixon, C.A. & Heilbrunn, O. Communist Guerilla Warfare Praeger, N.Y. 1955

Franklin, F.P. & Mark Osanko Modern Guerilla Warfare Free Press of Glencoe, 1960

Miksha, F. O. Secret Forces London, Faber and Faber, 1950 (Technique of underground forces derived from history; "brilliant")

Tannan, George. Communist Revolutionary Warfare Praeger, 1961, \$5.00 (The Vietnam in Indochina)

5.1.3. General Studies of Specific Areas

Barton, F. H. Salient Operational Aspects of Paramilitary Warfare in Three Asia Areas ORO-I-228 Aug. 1954 ADYb377

Bacalagan, Uldarico S. The Huk Campaign in the Philippines Manila M. Colocol and Co., 1956

Bautista, A. N. East Central Luzon Guerilla Military Review 25 22-27 March 1946

Crawford, Oliver. The Door Marked Malaya London, Harle-Davis, 1958

Douglas, William O. North From Malaya N.Y. Doubleday, 1953

Handy, I.T. & Smith, N.M. (ed.) Projected Situation Scenario S.E. Asia ORO Staff Paper ORO-SP-125 Jan. 1960 Sec.

Pye, L. W. Guerilla Communism in Malaya Princeton 1956

Sanchez, J. A. Guerilla Warfare in Luzon Armored Cavalry Journal 56 26-29 July-August 1947

Zavodny, J. F. Death in the Forest U. of Notre Dame Press 1962

North China Area Operations Record, Military History Section July 1937-May 1941 Hd. Army Forces Far East Japanese Monograph 176

USARPAC (C) - Special Report #413 Guerrilla Warfare in Southeast Asia

5.2. Operations

5.2.1. General

- Clark, C.E. et al. Effects of Min. Radios in Small Inf. Units ORO T-338
AD105859 May 1950
- Crockett, Anthony. Green Beret, Red Star London: Eyre and Spottiswoode,
1954 (Hunting of guerrillas by a tactical unit)
- Goldoni, J. E. The Jungle, Neutral Adversary Army Info Digest May 1961
- Marshall, S.L.A., Inf. Ops. and Wpns. Usage in Korea ORO-R-13 Jan. 1953
Winter 1950-51 (AD 342)
- Newcomer, D.R., (U) Personnel Anti-Radar Detector Eval U.S. Army Electronic
Proving Ground USAEPG-SIG930-167 Feb. 1961 Sec.
- The Role of Air Power in Partisan Warfare Human Resources
Institute Research Study No. 6 Vol.3, Dec. 1954 (AD74032)
- Rossiter, W., Guerrilla Warfare Requirements An. Univ. Spec. Ops. Res.
Office, Wm Rossiter June 1957 Secret
- UN Partisan Warfare in Korea, 1951-1954 (U)
Conf. ORD Technical Memm ORO-T-64 (AFPE)

5.2.2. Army and Marine Field Manuals

- FM 31-15 Operations Against Irregular Forces (May 1961)
- FM 31-20 Operations Against Guerilla Forces (Classified)
- FM 31-21 and 31-21 (A) - Guerrilla Warfare and Special Forces
Operations (S)
- FMFM 31 Operations Against Guerilla Forces (Marines)
- FM 31-72 Mountain Operations
- FM 31-30 Jungle Operations

3.3. Limited War, Capabilities and War Games

Navy Presentation to the DDR&E & PSAC Panels on Limited War
30 October 1961 (Conf)

[Anti Tank Weapons]

USMC Presentation to DDR&E & PSAC Panels on Limited War
Speech by Col. Anderson on Marine Corp. Helicopter Capability

USMC Presentation for DDR&E & PSAC Panels on Limited War
USMC on Tactical & Logistical Ground Vehicles

USMC Presentation for DDR&E & PSAC Panels on Limited War
Marine Corps Combat Amphibian Vehicles

Paxson, E.W. (U) The Sierra Project: A Study of Limited War
Rand Corp. E-317 May 1, 1958 Sec (Formerly RD)

Paxson, E.W. et al (C) Limited War in Thailand, Thai 1, 2, & 3.
Rand Corp RMs 2027-2035 May - Sept 1956 Sec.
(Formerly RD)

3.4. Area Topics of General Interest

3.4.1. Books

Benedict, Ruth. Thai Culture and Behavior (Cornell, Southeast
Asian Program, data paper #4, 1952.)

Dam Bo, Les Populations Montagnardes Du Sud Indo Chinois
(Saigon, France-Asie, 1950)

de Young, John. Village Life in Modern Thailand (University of
California, 1955, \$5.50)

Devillers, Philippe, Histoire Du Vietnam De 1940 A 1952
(Paris, Editions du Seuil, 1952)

Holland, William L., ed., Asian Nationalism and the West
(New York, MacMillan, 1953)

Huard and Durand, Connaissance Du Vietnam (Paris, Imprimerie
Nationale, 1954)

Johnson, A. Economics Assist in Thailand Department of State
May 1960

Lindholm, Vietnam, The First Five Years (Michigan State, 1959)

Menzel, James. "The Administrative Behavior," in William J. Siffin, ed., Toward the Comparative Study of Public Administration (University of Indiana, 1959, \$3.25)

Park, Irene, and Hugh Tinker. Leadership and Political Institutions in India (Princeton, 1959)

Palmer, Norman D.. The Indian Political System (Boston, Houghton Mifflin, 1961)

Purcell, Victor. The Chinese in Southeast Asia (Oxford, 1951)

Vella, Walter. The Impact of the West on Government in Thailand (California, 1955)

5.4.2. Periodicals of Frequent Interest

Airmen

Asia

Army (Asso. of U. S. Army, 1529 18th St., N.W., Wash. 6, \$5.00)

Army R & D (GPO)

Army Information Digest

Australian Army Journal

Far Eastern Survey (Vancouver, B.C.)

Journal of Asian Studies (R.S. Anderson, Box 2067, Ann Arbor, Mich.)

Marine Corps Gazette (Marine Corps Assoc., Box 1844, Quantico)

Military Review (Fort Leavenworth \$3.50)

Pacific Affairs (Univ. of B. C., Vancouver, B. C.)

Philippine Armed Forces Journal (PIO Troop Info and Educ. Div. GHQ, AFP, CAMP Murphy, Quezon City)

Royal United Services Institution Journal (Whitehall, London SW1 40a)

5.5. Bibliographies

Barber, Edda Photographic and Television Equipment & Techniques Adaptable to Space Flight
Literature Search No. 160 JPL Dec 1959 AD 232 484

Condit. D. M. A System for Handling Data on Unconventional Warfare ORO T 339 May 1956 AD 105 86J

Hanrahan, G. Z. & Sultzman, A. N. Annotated Bibliography of Asian Guerrilla Movements ORO T 264 July 1953 AD 22149

Miller, H. & Lybrand, W. A Selected Bibliography on Unconventional Warfare. Part I
Spec. Ops. Res. Office
American U. Oct 1961

5.6. Indicated Bibliography

5.6.1. Books

Springer-Verlag, Berlin and Göttingen. Encyclopedia of Physics, Vol. XLVIII. Geophysics II. Heidelberg, 1957

Smith Jones and Chasmar. The Detection and Measurement of Infrared Radiation, Oxford at the Clarendon Press, 1958

Proceedings of the IRE: Vol. 47, No. 9. Special Issue on Infrared Physics and Technology, September 1959

H. L. Harkorth. Infrared Radiation, McGraw-Hill, New York 1960

Kruse, McLaughlin, McQuistan. Elements of Infrared Technology, John Wiley and Sons, New York 1962

Holter, Hudelman, Suits, Wolfe, Zisis, Fundamentals of Infrared Technology, MacMillan Co., New York 1962

Advances in Electronics and Electron Physics, Vol. XI and XII. Academic Press, New York, 1959, 1960

R. H. Bube, Photoconductivity of Solids, John Wiley & Sons, New York, 1960

Progress in Optics, Vol. I, North Holland Publishing Co., Amsterdam, 1961

5.6.2 Reports

IBIS (Proceedings of Infrared Information Symposium) Office of Naval Research (Confidential and/or Secret)

The University of Michigan: Optical-Mechanical Scanning Devices, May 1958 AD No. 300319 (Secret)

Bendix Systems Division: Infrared Interpretation Manual: Tactical Targets, December 1960 AF30(602)-1937 AD No. 326 627 (Confidential)

IRZA - (U) Annotated Bibliography of Infrared Literature, Vol. I No. 1 through Vol VI No. 4, Infrared Laboratory of the Institute of Science and Technology, University of Michigan, Ann Arbor, Michigan

SECTION 6

Section 6.1, "Environmental Features" (pp. 6.1-6.16) which consisted largely of comments on a series of maps, Figs. 6.1.1-6.1.34 (pp. 6.30-6.63), has been omitted from this copy, owing to difficulties in reproduction.

6.2. Operational Considerations

This portion of Section 5 consists of a review of experience, judgment, and insight gained in past and current guerilla conflict. The purpose is to point up those particular operational factors which may indicate special requirements for detection.

6.2.1. Historical

Modern experience in the difficulties of anti-guerilla operations (or counterinsurgency) dates to World War II and the important guerilla campaigns in Europe, Russia, Yugoslavia, China, and the Philippines. After the war major guerilla conflicts occurred in China, Greece, Indochina, the Philippines, and Malaya, to name a few. Of the vast number of books and reports written about these conflicts, a large sample examined by the Contractor deal with strategy and tactics in the large. No comment will be made here on the general principles derived, which are by now well known. Few accounts of operations deal with success and failure points in ways that are useful in suggesting ideas for detailed corrective action. There are not many "engineering" books with quantitative data. For example, in a chapter commenting on the Viet-Nam Manual one text on partisan warfare (ref. 6.11) comments that the lessons on mine-laying and encirclement are omitted because "they don't add much to a knowledge of guerilla tactics". The few accounts which do treat the problem on this level and have been available form the basis for this discussion.

Experience gained in WWII against the Japanese in the Pacific, and in the recent classic campaigns in Indochina and Malaya seems most applicable

6.11: Heilbrunn, O. Partisan Warfare Praeger, New York 1962

to the S E Asian problem. In most reports guerilla warfare is referred to under the general (and sometimes misleading) heading of "jungle warfare". A good engineering bibliography of jungle warfare was prepared by the U. S. Army Artillery and Missile School Library. (ref. 6.12)

One of the most informative of the books found on the success of various "detection" techniques in anti-guerilla operations under jungle conditions is by a British Army brigadier who commanded a Welsh battalion in the Malayan Emergency. The observations which immediately follow are abstracted directly from his text (ref. 6.13).

The first observation made by Miers is that "it is the steady inexorable squeeze by a large number of troops simultaneously over the whole country which does the 'trick'". (It is precisely this factor which is so discouraging to the West. In successful, anti-guerilla campaigns a very large ratio of troops under arms to active guerillas have been needed for long periods. In Malaya, for example, it is estimated that approximately 335,000* men were placed under arms, against a maximum of some 8000 guerillas. By 1955 the cost had reached 700 million sterling. The Malayan Emergency lasted nearly 10 years and is estimated to have cost in all about 6 billion dollars.)

In the first phase of the Emergency there were perhaps 8000 CTs. On the average of one British planter and many natives were being killed per week. The rubber industry had been brought to a standstill. In 1952-54, with Templar as High Commissioner, CT's were reduced to less than 3000. In 1955 the third phase began with CT's largely broken up in small, isolated gangs, fighting to preserve the movement.

6.12 An Annotated Bibliography on Jungle Warfare No 28 (AD 263549) U. S. Army Artillery and Missile School Library, Fort Sill, Oklahoma, September 1961

6.13 Miers, R. Shout to Kill Faber and Faber, Ltd. London, England 1959 (written in 1955)

*(40000 British and Commonwealth Troops, 45000 police, and 250,000 part-time Home Guards)

There were still major difficulties. In Johore, for example, 90% of Chinese villagers were aiding the terrorists. The following observations are of particular interest:

In Jungle Operations

Most of the operations were in the jungles and swamps which cover four-fifths of Malaya. In 5-man jungle patrols men walked in line, five yards apart, the lead man looking ahead, the next two men watching left and right respectively, the fourth man watching overhead, and the fifth man watching the rear.

Fires are dangerous because the smoke, trapped under the canopy, is detectable at considerable distances.

At all times (perhaps for several weeks) men spoke in whispers, for voices carry far in the jungle.

CT jungle camps were occasionally surrounded by carpets of dry palm fronds to give warning of approach.

CT's could not put on civilian clothes and enjoy a change of scenery for a while. Special Branch coverage was too good and the pallor of their skins from long jungle living would give them away. Even two weeks in the sunless jungle will be distinguishing. A multitude of little scars from inevitable jungle sores are another giveaway.

For ambushes great precautions are taken---even hair cream must be washed off as the natives have a keen sense of smell.

The CT's developed an animal-like instinct for danger and made great speed in flight through the jungle.

The operational margin of success with tracking does was very small despite Herculean efforts. However, the Sarawak (Borneo) trackers, in favorable circumstances, could follow a CT for days on end.

° In helicopter patrol it was discovered that a very large number of small clearings existed, at least large enough to permit a man roping down.

° While patrolling a rentice (boundary line cut through the jungle) automatic weapon fire and single rifle shots were heard----estimated to be 3000 yards away.

° The jungle rivers are often hidden by forest canopy closed overhead. In the surrounding swamps underwater bridges are concealed by the CT. In swamps troops always make considerable noise.

° Of many good ideas --- the Corridor theory was the most rewarding-- that the CT would favor the easiest routes when moving through the jungle. In one operation all the best routes seemed to lie within two half-mile wide belts leading north into the jungle. The ratio of contacts to patrol hours went up markedly.

On Food Control

° Everyone of the 50,000 inhabitants in the area would be physically searched every time they left their villages.

° To the CT rice is a must --- used in some form at every meal --- or physical stamina declines rapidly.

° Rice was poured by sympathizers, a handful at a time, into buried glass acid jars.

Additional opinion about jungle warfare is gleaned from several other sources:

Ref. 6.14

°Since jungle and night fighting are somewhat similar, units unable to train in actual jungle should achieve a high standard of night training.

°Primary jungle visibility is limited to 20 - 30 yards. On hills foliage is thin, but in valleys very dense. It is never impassable to infantry. Secondary jungle, which is growth over previous clearings, is primarily very dense fern and bramble, impenetrable without cutting instruments. In coastal jungles, mangrove swamps and 4 - 8 ft. kunsai grass must be walked around, generally through water. Paddy fields are difficult in rainy season but not impassable to troops. Rubber plantations when mature, give up to 200 yards ground visibility.

°Normal jungle sounds and smells should be learned.

°Since jungle, because of poor visibility, favors the attacker, a purely passive defense is doomed to failure.

Ref. 6.15

°In night defense of outposts and communities the trip flare is a very useful aid to shooting.

Ref. 6.16

°The most serious difficulty was inability to establish contact between the air element and the surface element operating under the tree canopy (Panama).

Ref. 6.17

°If insect repellent is applied to large numbers of men its characteristic smell is unmistakable. Usually, however, the danger of

6.14 Notes on Jungle Warfare, Military Review 24, 99-101 August 1944

6.15 Training the Jungle Shot, Australian Army Journal 100, 26-28 Sept. 1957

6.16 Report of Environmental Operation, Tropical Wet 1960, U.S. Army Transportation Board Ft. Eustis, Va. (AD 2603221)

revealing (the) ambush by undue movement to avoid bites is the greater, and it is usually better to apply the repellent.

°All weapons should be cocked, as the sound, even from half cock position, will warn the enemy.

Ref. 6.18

°Whispering is hard on the voice and leads to misunderstandings and should be avoided in favor of low talking.

°Marching across open paddy land raised clouds of dust, visible for miles.

°Jungle was thin on the ridges - impossibly thick in chaungs (streams)

Ref. 6.19

°Trail junctions --- generally provide the only avenue of communications, supply and evacuation in a jungle.

°Distinguishing between small and large enemy units is very important in tactical planning.

°Jungle noises are quickly learned and interpreted.

°Movement to final objective was almost entirely by trail --- flankers cannot maintain the pace.

°In many places men had to cove for many yards from vine to vine, without touching ground.

Ref. 6.20

°Most jungle terrain is very rugged --- with alternating swamps, deep valleys and steep ridges --- after several men walk a trail, it gets muddy and slippery.

6.17 Austin, M. Some Thoughts in Ambushes in Tropical Warfare
Australian Army Journal

6.18 Fergusson B. Beyond the Chindwin Collins 1945

6.19 Combat Lessons from the Jungle Infantry 52(2) 12-13 Mar-Apr 1962

The best avenues of travel are along ridges and across saddles ---
native trails are almost invariably along ridges.

Rapid changes in jungle features quickly obsolete maps.

Trip wires --- to rattlers, mines, or flares (for defensive
position).

Aerial reconnaissance will seldom show trails --- but will define
ridges, etc.

Due to low wind velocities beneath canopies, vapors, smoke, etc.,
diffuse slowly.

Ref. 6.11

- o Rumble RR ^{Slopes} ~~shaped~~, curves, and high embankments are favorite targets for ambush.
- o The Viet Minh operated against RR's with only an assault group and a demolition group and without the normal reserve group.
- o In Malaya aerial reconnaissance ranked second in importance to transport---the British favored visual (eyeball) reconnaissance as most reliable.
- o Pilots in Indochina had to search for underwater plank paths.
- o In Indochina the French used liaison planes with convoys to spot ambush. The unarmed planes were not helpful.
- o The Viet Minh gave highest priority to raids on airfields.

The foregoing excerpts from a variety of sources serve to give a general pattern of injunctions which are applicable to the kind of warfare now being encountered in SE Asia. No specific mention was found of any advanced electro-mechanical detection gear. Even listening devices apparently were not employed. Only occasional reference to IR night-sights is found and these are never favorable.

Various kinds of trip flares and other devices were employed in ambush and as protective devices for defensive encampments.

The closest approach to special efforts of the type considered in this report were military dogs, as trackers, with which experience was poor; imported native trackers, with which experience was excellent; and cooperative techniques involving visible markers, with which only occasional success was attained.

6.2.2. Current

The Vietnamese Army has 205,000 men under arms. In addition there are five Civil Guard companies in each province. 4000 strategic hamlets were completed in 1962, adding some 500,000 inhabitants to government control.

Vietnamese population, including some 800,000 refugees from North Vietnam is estimated at 12,500,000, mostly in the Annam coastal strip and the Mekong Delta. Of this population Saigon/Cholon has 1.8 million, Hue 100,000 and Tourane 85,000.

Comprehensive reports on operational experience in the current conflict in Vietnam have not been obtained. The following opinions or observations were gleaned about equally from scattered reports, news correspondent accounts, or from recent travelers to the region. Their accuracy and generality cannot be vouched for:

- o VC guerrillas attack remote villages with little warning, for short periods, and break off quickly if VN forces appear. Pursuit has been largely unsuccessful but improves with helicopter support. After breaking off, in relatively open country, VC's hide in root cellars, along canals, in prepared burrows with underwater entrances, and for short periods under water. In jungle the VC's can disperse and seem to move more rapidly, and steadily than pursuers. Coordination of tracking elements in jungle is extremely difficult. No satisfactory detection device for jungle pursuit has been found.
- o Exact location of jungle camps and major bases from the air has been generally impossible. In the 22nd Division area (Ref. 6.21)

a large VC camp, with training ground, field hospital, and arms dump was captured. 48 bodies were counted. The area had been reconnoitered by helicopters for weeks but no trace of the camp, sheltered by an overlying canopy, was seen. Low altitude aircraft and helicopters are subjected to dangerous and often fatal ground fire.

- o VC's live in many villages without betrayal and are "indistinguishable" from farmers. They hide cloth-wrapped rifles in rice paddies during the day and have extensive diggings where arms and munitions are stored. It has been estimated that of every five persons, 1 is actively pro-Viet Cong and 1 actively against.
- o Minor and major VC ambushes have been prepared and executed with great success, even though preparations must have been visible to locals for days. Pursuit after ambush has frequently been hours late and is generally unsuccessful. Excellent cover and good escape from ambushes is available nearly everywhere.
- o Mortar fire against outpost areas is a frequent tactic.
- o A UN army regiment in the high plateaus has complete operational control over its area including provincial guards and self-defense corps (Ref. 6.22)
- o Paddies, trails, and helicopter landing areas are booby-trapped with nailboards and bamboo spikes. Trails are spiked for

6.21 Marshall, S.S. An Exposed Flank in Vietnam; Reporter, June 7, 1962.

6.22 Jablonsky, H.J. Counterinsurgency is Your Business; Army Information Digest, 17 [?], July 1962.

perhaps 200 yards and are then impassable as the surrounding brush is too thick to penetrate. (Ref. 6.21).

- o Infiltration from extraterrestrial sanctuaries has been virtually uncontrollable.

Ref. 6.22

- o In Indochina--the rebels put cats in traps to lure dogs and ambushed the French.
- o The northern hill tribes--the Sudang, Bahnai, Jarai, Rhode--traditionally avoided the Vietnamese--guerilla bases appeared in the highland jungles.

Ref. 6.23

This article shows:

- o Swamp patrols up to the waist in water.
- o Vast flooded areas with no clear pathways or dikes.
- o VC attacking a village almost surrounded by wet paddyland.
- o A lone VC fleeing through a flooded paddy.

Since transport problems for operations in many areas have not been satisfactorily resolved there is a premium on all gear being of low weight and easily transportable by manpack. The rule is that the gear must be clearly more valuable than the materiel it must displace.

In a recent study by the U.S. Army Signal Board (Ref. 6.25) it was concluded that--ground-based combat surveillance and target acquisition equip-

6.23 White, P.T & Garrett, W.E., South Vietnam Fights the Mud Lid; National Geographic. October 1961.

6.24 Chapelle, D. Helicopter War in South Vietnam; National Geographic. November 1962.

ment was heavy, bulky, difficult to site and subject to such severe operational limitations in dense jungle that they are considered to be of little practical value. It was recommended that--since airborne CS & TA equipment is mostly in various stages of research and development--additional emphasis and reliance be placed on (obtaining) airborne sensory devices even though their effectiveness will also be reduced in jungle areas.

The chief hopes in general, are that coordinated ground-air operations can improve the chances of closing with guerillas, that the element of surprise can be turned against them, and that they can be flushed from hiding places.

6.2.3. Future

The anti-guerilla campaigns which have been concluded successfully, as in Greece, the Philippines (Hukbaluk), and Malaya seem to have had several common features. First, the main guerilla bases could be located and isolated from outside help and escape. Second, the local populace could be rigidly controlled, or disaffected. Third, control of the entire affected area was secured step-by-step and with the use of overwhelming forces. Fourth, unremitting pressure was maintained on the guerillas by vigorous, continued, and unpredictable offensive action. These may reasonably be taken as objectives for counter-insurgency operations in SE Asia. The hope is that overwhelming forces can be obtained without overwhelming numbers.

In South Vietnam (and perhaps later in Thailand) one great difficulty not present in the three successful cases mentioned, are the enormous borders

6.25 Communications-Electronics in Limited War (Jungle Operations), U.S. Army Signal Board Case 689, May 1962.

against unfriendly territory. It is difficult to see how the first element of the successful campaigns can be finally resolved unless some kind of effective border control, either political or technical, can be realized. It is possible that advanced technology, applied to border surveillance, may be of some help here. In spite of the obvious difficulties this seems a prime field for effort. The second factor is not clearly a military matter and hence is not discussed here.

A program for strategic hamlets, already underway, may secure some of the necessary areas, piece by piece. Detection gear will be useful in defense of these sites, by increasing warning and perhaps reducing the size of garrison necessary.

The primary utility of advanced detection technology will be tested in improving the efficiency of combat forces trying to attain the fourth objective. In these operations advanced detection of attacks and ambush, pursuit, and location of camps are prime considerations. The equipments employed must be highly reliable, as in general they will be replacing other equipment, rugged and simple, as maintenance will be a problem. They must be usable by native troops, and should result in a marked improvement in overall combat efficiency.

[Although the search for efficiency in combat and other improvements cited are very important it is worthwhile pointing out that if massive measures such as those undertaken by the British in Malaya are employed in Vietnam, the major requirement on manpower is not combat forces but those employed to deny insurgents civil support.]

SECRET

SECTION 7

OPTICS

This Section is devoted to a discussion primarily of novel uses of infrared in anti-guerrilla applications. The state-of-the-art on high-resolution thermal mappers is discussed in 7.1. In 7.2 the utility of aerial surveillance for fire-detection, early estimates, a survey of S. E. Asian heat sources are covered. Also, physical factors affecting detection and experience are discussed. In 7.3, the geometrical factors affecting fire detection experiments and detection reliability are examined in detail and the current status of work is criticized. A research program is suggested and an outline is given of an instrument designed for tactical use. In 7.4, the question of wake detection is reviewed and experimental programs are recommended. Experience with current military IR equipment is discussed in 7.5, and some other potentially useful applications are briefly discussed. In 7.6 and 7.7, some of the factors underlying instrument performance and design are examined with special reference to detector problems.

-7.1-

SECRET

7.1 STATE-OF-THE-ART OF HIGH RESOLUTION THERMAL MAPPERS

CONTENTS

- 7.1.1 Introduction
- 7.1.2 Principles
- 7.1.3 State-of-the-Art Equipment
- 7.1.4 Present Limitations and Expected Future Improvements
- 7.1.5 Conclusion

7.1.1 Introduction

Devices for mapping of IR-observables are of considerable current interest. It is expected that devices of similar principle of operation will be useful in counter-insurgency work in Southeast Asia or similar territory in the event that guerrilla operations produce telltale evidence. This paper consists of a general description of the principle of thermal mappers and a quantitative formulation of their characteristics (7.1.2), a brief description of a representative high-quality equipment (7.1.3) and, comments on the limitations and future improvements of contemporary mappers (7.1.4). It should be emphasized that these devices show considerable promise in applications to the surveillance of low-temperature targets in the open, such as for instance thermal wakes.

7.1.2 Principles

A thermal mapper observes an area and records the emitted infrared in a particular wavelength region. At present all such devices use mechanical scanners since no suitable IR image tubes are available. Various mechanical

scanning patterns can be employed, operating in either the object plane or the image plane. Single-element or multi-element (linear array or mosaic) detectors may be used. In the case of airborne equipment using a single-element detector and object-plane scanning, the target field is usually dissected in one direction by the scanning element (in the simplest form a rotating mirror); the detector sees successively the elements of a linear strip ("line") of the target field. The element size ("spatial resolution") is determined by the instantaneous field-of-view of the equipment unless "shaped aperture" (and data processing required by it), is used. The "lines" constituting the target field are then scanned by virtue of the motion of the aircraft. By adjusting the scan rate (lines scanned/sec) to the ratio of vehicle ground speed to vehicle altitude, the entire target field can be scanned without overlap or "underlap." By exposing film to a light spot modulated by the detector output and moved relative to the film in conformity with the scanning motion, a one-to-one correlation between the density distribution of the developed film and the irradiance in the i.f.o.v.* may be obtained.

Key characteristics of the resulting thermal map are its "spatial resolution," and "temperature resolution" (i.e., the minimum temperature difference of two "gray body" elementary target areas of identical emissivities which cause a discernible difference in density). Since the irradiance from an extended source is directly proportional to the field-of-view, the two characteristics tend to oppose each other. That is, for increased spatial resolution, temperature resolution must be sacrificed and vice-versa.

* Instantaneous field-of-view. .7.3.

SECRET

SECRET

7.1.2 Quantitative Characteristics of Airborne Mechanically Scanning Thermal Mappers

Let us specify that

- Ω = instantaneous field-of-view (steradians)
- α = total scan angle (radians)
- V = vehicle ground speed (km/sec)
- H = vehicle altitude (km)
- M = number of elements scanned per second (sec^{-1})
- A_A = effective aperture (cm^2)
- f = focal length optics (cm)
- A_D = area semiconductor detector (cm^2) = $\Omega \alpha^2$
- D^* = effective detector detectivity ($\text{cm sec}^{-1/2} \text{watts}^{-1}$)

In the case of a linear (line) scanner the number of elements scanned per second and required bandwidth are

$$M = \frac{V\alpha}{H\Omega} \approx \Delta f$$

System sensitivity can be specified in terms of the noise equivalent power of the detector

$$\text{NEP} = \frac{A_D^{1/2} (\Delta f)^{1/2}}{D^*} = \frac{A_D^{1/2}}{D^*} \left(\frac{V\alpha}{H} \right)^{1/2} \quad (\text{rms watts}) \quad (1)$$

and the noise equivalent power density is

$$\text{NEPD} = \frac{f}{A_A D^*} \left(\frac{V\alpha}{H} \right)^{1/2} \quad (2)$$

SECRET

~~SECRET~~

If the radiance of the target field (in the spectral band $\Delta\lambda$ for which the value D^* applies) is $R_{\Delta\lambda}$ (watts cm.⁻² sterad.⁻¹) and the effective transmission of the path is $t_{\Delta\lambda}$ ⁽¹⁾, then, at a signal-to-noise ratio of unity

$$\text{NEPD} = t_{\Delta\lambda} R_{\Delta\lambda}$$

From the above identity, A_A is⁽²⁾

$$A_A = \frac{f}{D^*} \frac{1}{t_{\Delta\lambda} R_{\Delta\lambda}} \left(\frac{Vc}{H}\right)^{1/2} \text{ (cm}^2\text{)} \quad (3)$$

Conversely, the instantaneous field-of-view, Ω , is:

$$\Omega = \frac{f}{D^* A} \frac{1}{t_{\Delta\lambda} R_{\Delta\lambda}} \left(\frac{Vc}{H}\right)^{1/2} \text{ (steradians)} \quad (4)$$

Then, the subtended area, that is the spatial resolution at vertical look,

A_0 is

$$A_0 = H^2 \Omega \text{ (km}^2\text{)} \quad (4')$$

⁽¹⁾ At a spectral radiance of the target field of $H(\lambda)$ (w.cm.⁻² sterad.⁻¹ micron⁻¹), the values of $t_{\Delta\lambda}$, $R_{\Delta\lambda}$ and D^* , are determined from the following relation:

$$\int_{\lambda_1}^{\lambda_2} t(\lambda) H(\lambda) D^*(\lambda) d\lambda = t_{\Delta\lambda} R_{\Delta\lambda} D^*$$

There, λ_2 and λ_1 are the upper and lower wavelength limits, respectively, of the spectral region $\Delta\lambda$.

⁽²⁾ If scanning efficiency, s , is less than unity, the required aperture A_{As} is larger than the ideal aperture A_A and $A_{As} = \frac{A_A}{s^{1/2}}$.

~~SECRET~~

~~SECRET~~

Of course, σ cannot be smaller than the resolution of the optical system. This criterion is relatively easily satisfied for object plane scanning where only a small well-defined image field is required. For image plane scanning, the optical system may be difficult to design if the spectral region of detection extends beyond a few microns and a wide angular coverage is required. Moreover, the resolution attainable in practice may be limited also by the mounting stability of the optical system because of vehicle vibration and flight roughness. Also the time constant of the detector must be shorter than the dwell time M^{-1} , by a factor of about 3 or 4, or the signal from a resolution area will not build up to full level, leading to a false indication of the irradiance from the resolution area with respect to the irradiance from an extended area of the same radiative characteristics. Therefore, long detector-time-constant can only be tolerated when a number of independent detectors--arranged in an array parallel to the direction of flight--are being used to sufficiently increase the dwell time per detector.

Since the target area subtended by the field-of-view is dependent on the scan angle, the spatial resolution varies along a scan line with scan angle. This variation may be expressed by the ratio of

$$\frac{A_{\sigma_x}}{A_0} \sim \frac{1}{\cos^3 \sigma_x} \quad (5)$$

where A_0 is the resolution area of the terrain at vertical look and A_{σ_x} is the resolution area at the scan angle of σ_x . (3) A_0 is the minimum attainable

(3) The approximate variation with the inverse of $\cos^3 \sigma_x$ is due to the fact that the projected area varies with the inverse of $\cos^2 \sigma_x$ and that the subtended area is proportional to the projected area and--approximately--to the inverse of $\cos \sigma_x$. In effect, in this approximation, we neglect terms containing $\sin^2(1/2 \Omega^{1/2})$ and we take $\cos 1/2 \Omega^{1/2}$ as unity.

resolution for a given system. By changing the scan pattern to a circular scan one could make the size of the resolution area constant but the resolution would be worse than the best achievable, as indicated by Eq. (5).

For a target field of gray body radiator, $R_{\Delta\lambda}$ is

$$R_{\Delta\lambda} = \beta_{\Delta\lambda} \epsilon p T^4$$

where

$\beta_{\Delta\lambda}$ = spectral efficiency

ϵ = effective emissivity of target field

T = effective temperature of target field in $^{\circ}\text{K}$ and

$p = 1.8 \times 10^{-12}$ watts cm.^{-2} sterad. $^{-1}$ ($^{\circ}\text{K}$) $^{-4}$.

The change of $R_{\Delta\lambda}$ with temperature, $\frac{dR_{\Delta\lambda}}{dT}$ is

$$\frac{dR_{\Delta\lambda}}{dT} = \beta_{\Delta\lambda} \epsilon p T^4 \left(\frac{4}{T} + \frac{d\beta_{\Delta\lambda}}{dT} \cdot \frac{1}{\beta_{\Delta\lambda}} + \frac{d\epsilon}{\epsilon} \cdot \frac{1}{\epsilon} \right)$$

and

$$\Delta R_{\Delta\lambda} \sim R_{\Delta\lambda} \left(\frac{\Delta T}{T} + \frac{\beta_{\Delta\lambda} \Delta T}{\beta_{\Delta\lambda}} + \frac{\Delta \epsilon \Delta T}{\epsilon} \right) \quad (6)$$

Thus, from Eq. (3) and (6), the temperature difference at which the change in signal equals the detector noise, ΔT is

$$\Delta T = \frac{1}{4} \left(\frac{f}{A_{\Delta\lambda} D^2 \epsilon_{\Delta\lambda} R_{\Delta\lambda}} \left(\frac{V\sigma}{H} \right)^{1/2} - \frac{\beta_{\Delta\lambda} \Delta T}{\beta_{\Delta\lambda}} - \frac{\Delta \epsilon \Delta T}{\epsilon} \right) \quad (7)$$

Since the emissivity is a weak function of temperature and at small values

SECRET

of ΔT (i.e., $\Delta T < 10^{-3} T$) the term of $\frac{\partial^2 \Delta T}{\partial \lambda^2}$ is insignificant for spectral regions practical to consider because of detector sensitivity, the second and third terms in Eq. (7) may be neglected. Then, the "temperature sensitivity," $\epsilon \Delta T$ is

$$\epsilon \Delta T \approx \frac{f}{A D^2} \cdot \frac{1}{\epsilon \Delta \lambda^4 T^3} \left(\frac{V_G}{H} \right)^{1/2} \quad (8)$$

It is of interest to note that the temperature sensitivity defined for completely filled field-of-view is practically independent of scan angle. This is so because the radiant power in the field-of-view (except at the extremes of the scan angle approaching $\pm 90^\circ$) is independent of scan angle and the decrease of path transmission with increasing path-length is insignificant under average meteorological conditions.

7.1.3 State-of-the-Art Equipment

The most recent thermal mapping device, to our knowledge, is the AN/DAS-5(EX-1), developed by Texas Instruments under Army Contract DA-36039SC78224. It appears to be a representative of the best equipments within the capability of the present state of the art.

Specifications are that

$$0.05 \geq \frac{V}{H} \geq 1.0 \text{ (radian/sec)}$$

Scan angle:	180°
Scan rate:	250 scans/sec (lines/sec)
Instantaneous field-of-view:	2 mrad
Detectors:	InSb(77°K) (3μ-5μ) Ge ÷ Hg(30°K)(8μ-13μ)
NERV (in $\Delta T = 500$ K:ps):	$1.85 \times 10^{-10} \text{ W/cm}^2$ $3.06 \times 10^{-11} \text{ W/cm}^2$
Noise Equivalent Temperature Sensitivity:	0.3°K 0.05°K

SECRET

~~SECRET~~

Power requirement: 900 VA 115 V+
50 W 28 VDC

Cooling for
Ge + Hg detector: 1 liter liquid Ne for 100
hours of cooling

or: 1 liter liquid He for 3
hours of cooling.

The film is exposed in the airplane and is developed on the ground*

The detectors are said to be easily interchangeable. It has been reported that modification to provide a 10-mrad instantaneous field-of-view is easily accomplished.

In the latter case, the noise-equivalent temperature sensitivity is said to be 0.006°K with Ge + Hg detector. Under the same condition the temperature sensitivity using InSb would be 0.026°K .

The provision of flexibility of selection of spectral region and spatial temperature resolution may be important in use of the equipment for initial studies since the sizes of target areas of interest and their temperatures relative to the undisturbed (natural) terrain are unknown. We have heard that the equipment provides for expansion of any selected region of the film's density range. This feature is very valuable for enhancing slight radiative differences in a target field.

Of two original units of this equipment one unit was tested by the Signal Corps under tropical conditions in Panama, and returned to USA ERDL; the other unit was delivered to Fairchild at the Yuma Test Station for drone tests. We understand 10 units are being procured by the AF for recon use in the RF110.

Texas Instruments has built a similar equipment for the Scripps Institution of Oceanography with an instantaneous field-of-view of 20 mrad and an expected temperature sensitivity of about 0.003°K in the spectral region between 8 and 13 microns.

*or magnetic tape, or a "last-mile" electronic display may be used.

~~SECRET~~

~~SECRET~~

7.1.4 Present Limitations and Expected Future Improvements

In principle, the performance of thermal mappers is limited by the sensitivity of the detectors and as better and better detectors become available, thermal mapper performance should improve proportionally. In practice, however, two other important factors must also be considered. There are the stable platform and the recording (display) art which are perhaps limiting the presently achievable spatial resolution. In addition, the recording medium limits the dynamic range of information.

A serious limitation on performance is due to scanning noise, especially in image-plane scanning. Object-plane scanning has the disadvantage of requiring bulky equipment. Moreover, constant resolution and scale factor in the entire map may or may not be obtained depending on the scan pattern.

IR image tubes, when perfected, should remove scanning difficulties and give some improvement in sensitivity by virtue of the reduction of the effective bandwidth from the inverse of the "dwell-time" (the time an element is being scanned) to the inverse of the "frame-time" (the time the entire field is being scanned) as is the case in conventional television. At identical surface sensitivities for the single element detector and for an image tube, an improvement in sensitivity proportional to the square root of the ratio of the respective bandwidths could be expected. However, at least for a certain length of time, a full realization of such gain will probably be prevented by noise produced in electronic scanning. Unfortunately we are not able to predict when suitable image tubes will become available.

~~SECRET~~

SECRET

As the performance of thermal mappers improves, the amount of information in future maps will increase also. Of course, an increase of information per se, is of little use without proper evaluation. Since contemporary maps may already saturate the capacity of human (visual) evaluation (the accuracy and rate of visual evaluation is definitely less than desirable), the importance of automatic data-processing is evident. However, an assessment of the utility of automatic data-processing applied to thermal mappers and a prediction of future advances cannot be made here, in any appreciable detail. But should be noted, that a significant progress could be assured if, for instance, the existence of a peculiar one dimensional but low thermal gradient in a two-dimensional field could be in (almost) real time, automatically established. Such a capability would considerably increase the merit of wake-detection, when, of course, this proves feasible.

7.1.5 Conclusion

Thermal mapping is a highly developed art. Nevertheless, future improvement can be expected primarily from superior detectors, including image tubes, as far as sensitivity is concerned. Concerning resolution, improvement in auxiliary equipment (such as stable platform) is perhaps the more urgent. Improvement in optics by judicious use of aperture-shaping, is also promising. However, the need is perhaps the greatest for automatic data-processing. Although these needs have been recognized and the lack of their fulfillment is badly felt, the capability of contemporary mapping techniques in appropriate application should be very useful in guerrilla warfare.

SECRET

CONTENTS

7.2. Fire Detection

7.2.1. General

7.2.1.1. Introduction and Summary

7.2.1.2. Campfire Calculations

7.2.1.3. Heat Sources

7.2.2. Detection

7.2.2.1. Direct

7.2.2.2. Indirect

7.2.3. Forestry Service Program

7.2.4. Operation Tropicana

7.2.4.1. Introduction

7.2.4.2. Planning

7.2.4.3. Experiment

7.2.4.4. Critique

~~SECRET~~

7.2.1. General

7.2.1.1. Introduction

Very early in the study it was suggested that aerial detection of fires in jungle might be a very good indication of the presence of guerilla encampments, given other necessary data. As pointed out in the preceding section, no other aerial surveillance technique had been useful in locating such bases.

It was argued that a) rice was an absolute essential in guerilla diet and that b) rice must be cooked. This argued for the existence of campfires and the possibility that careful thermal mapping of an area might detect such fires. If the canopy had even small holes and the mapping was right, a direct look at fires could be obtained. As seen earlier in Section 6 it is indeed very likely that many small holes will exist. If there were no holes, but enough large fires, indirect detection of heated canopy, or warm air columns might be possible.

In area D, about 10,000 VC were supposed to be normally encamped. Cooking rice for these men each night would require some 3000 KW hours of campfires. Initial calculations (see 7.2.1.2) argued for detectability.

Arguments against the utility of such surveillance were that a) individuals cooked their rice in small pots, over charcoal stoves, or on very small fires; b) that community pots would obscure large fires; c) that campfires probably weren't common, d) that there were always many natural fires in the woodlands; and e) that in many seasons of the year, due to high humidity, clouds, or rainfall, IR reconnaissance would be

*B. Alexander after Far East Survey Trip (DRC First Monthly Letter Report)

~~SECRET~~

impracticable. To resolve some of these questions on heat sources, CDTC (Thailand) made inquiries in the Far East (see 7.2.1.3).

A survey of U. S. activity disclosed that the U. S. Forestry Service was already running experiments on fire detection (see 7.2.3). The Contractor studied this problem in detail and recommended an additional immediate program involving a planning exercise to define environmental measurements and controlled field tests. During the study ARPA funded a piggy-back experiment in Operation Tropicana (see 7.2.4).

Factors affecting controlled experiments on fire detection are defined in 7.2.2.1.

The problems of surveillance for fires with existing equipment, the design of suitable field experiments, and a suggested optimized equipment are covered in the next major sub-section (7.3).

There seems to be, currently, high enthusiasm for this technique and the use of present thermal mappers in operational reconnaissance. The Contractor believes (1) that the requisite basic and field test programs still must be planned and carried out; (2) that existing thermal mappers are not in general suitable for use for fire detection in S. E. Asia, and (3) that a very suitable equipment could be rapidly developed.

7.2.1.2. Campfire Calculations

An early calculation to estimate campfire output is included here for completeness.

SECRET

a) The Canonical Campfire

Say that 1 liter of water must be held at boiling temperature for twenty minutes to cook one 24-hour rice ration. If the 3×10^5 joules needed were supplied in an equal time period the average heat input would be 250 watts. Evaporation, radiation, and convection losses, with care, might be comparable. Hence, for a campfire very well-coupled to the pot substantially 500 watts would appear as low temperature heat.

The inefficiency of such a campfire will show in two ways: radiation directly from the hot coals (or flames) and radiation, conduction and convection from the walls, etc. of the fireplace.

The coals (at about 2000°C) radiate roughly 1 watt/cm^2 in the visible, 70 watts/cm^2 in the near IR (.75 - 1.5 μ) and 125 watts/cm^2 in the intermediate IR (.75 - 10 μ). Thus, even one square inch of exposed hot coal would cause the radiation of more than 1 KW. Exposed flames radiate less per unit area totally, but almost as much in the visible-near IR regions. A reasonable guess for a small fire is that at least 500 watts would be radiated from the coals or flames (corresponding to one-half square inch of exposed ignited coals.)

Since wall losses, etc. are very much like those from the pot, it is not profitable to make very fine distinctions. It is

reasonable to assume as much heat ends up in exposed walls, grates, supports, etc. as ends up in the pot, i. e. about 500 watts. The 1 KW assigned to the pot and wall losses must be divided between heat which warms the air and radiant heat. If we assume the radiant heat emitted from 100°C surfaces, .6 m² of radiator would suffice.

Finally, an additional quantity of heat (fortuitously about 500 watts also) can be expected to heat the air in the vicinity of the fire. The hydrodynamics of this flow is quite complicated and we have not, as yet, been able to estimate its characteristics.

In summary, then, it seems to us reasonable to postulate a canonical small cooking fire* with the following characteristics:

- 3.3 cm² of coals at 2000°C radiating 500 watts;
- 4500 cm² of walls, etc. at 100°C radiating 500 watts;
- A rising air column (size and temperature not yet determined) which carries away 500 watts.

The rising column also has gases and particles entrained which may be of interest.

b) Optical Transmission Paths Thru the Jungle

We have virtually no information from which the absorption and scattering of optical and IR signals by jungle foliage can be deduced. A library search will be initiated shortly and may produce some data.

*Fires for other purposes can easily be 10-100 times larger than the small fire discussed and in fact larger fires may be normal if group cooking is practiced.

A very rough bound on the attenuation of visible radiation from fires in the jungle along paths to airborne sensors may be deduced from the alleged fact that one can read a map in most jungle conditions during broad daylight, but cannot at dawn and/or dusk.

The noon (clear day) illumination (in the visible) at the jungle top is about $.05 \text{ w/cm}^2$ and the dusk illumination (sun's altitude = zero degrees) is $10^{-3} \text{ watts/cm}^2$. The illumination required for reading a map is somewhat greater than full moon illumination ($10^{-8} \text{ watts/cm}^2$). Assuming that attenuation down to ten times full moon illumination is required to deny map reading, the transmission constant τ in the visible can be estimated by

$$5 \times 10^{-2} \tau > 10^{-7}$$

and

$$10^{-3} \tau < 10^{-7}$$

or

$$10^{-4} \tau > 10^{-6}$$

The geometry of the path through the jungle will be worse for an airborne scanner than for moonlight. The total field of view of the airborne device will be of the order of 1 steradian, hence the maximum zenith angle is $1/2$ radian, and, in consequence, the attenuation is substantially that of vertical incidence transmission.

The estimates made above for attenuation in the visible can be extended to at least the near IR (.75 - 1.5 μ) by the following argument:

The transmission of optical radiation through the jungle is partly by means of statistically occurring openings in the cover and partly by scattering from large scatterers such as leaves, branches, etc. In the case of paths through openings in the cover, geometric optics certainly apply for the near and probably the far IR. In any case, transmission would increase with wavelength due to diffraction. In the case of scattering, the wavelength sensitivity of the surface reflection coefficient will be controlling. Data available for the near IR indicates that the reflection coefficient is, if anything, higher than in the visible. The reflection coefficient of the jungle foliage at far IR may be as much as 10 times lower.

The fact that in both mechanisms producing transmission, long-wave IR propagates at least as well as the visible makes it safe to use the bounds applicable to visible transmission to the near IR. Since the dominating mechanism is not known, the bounds do not apply to the far IR.

7.2.1.3. Heat Sources

No data on the incidence of natural fires has been obtained, but a survey of likely heat sources was made by CDTC (Thailand) (ref. 7.1.). For convenience these data are repeated below:

"Discussions with appropriate personnel in Vietnam have resulted in the following conclusions:

a. Heat Source: A heat source that can be associated with most guerrilla groups is the cooking stove. This stove is a portable

7.1 Ltr. 18 Sept 62 T.W. Brundage to R. C. Phelps, Asst. Dir. Remote Area Conflict, ARPA

ceramic or baked clay device common to the East and frequently called by the Japanese name "hibachi". Charcoal is the universal fuel. The clay stove is a hollow vertical cylinder 10 to 14 inches in diameter and 14 to 18 inches high and open at the top. A grate on which the charcoal is placed is located above an air-port in the side of the cylinder. The food is cooked in a round-bottom iron kettle or flat-bottom pan which is placed directly over the open top of the stove. This type stove is large enough to cook the food for a squadron (8-12) of men. This heat source will be employed in all regions from the delta country to the mountains. A second heat source is the small campfire. This fire is found only in the mountainous regions and is employed during the early evening hours for warmth. The fuel is wood, as opposed to charcoal and the fire is laid on the ground. The fire is carefully tended so as to produce the minimum of smoke and remain small (fire - bed of 12 to 18 inches diameter) in order to permit rapid extinction. The use of other fuels is extremely unlikely because of logistic problems.

b. Shelter: Under the majority of conditions the charcoal stove will be used outside of huts or lean-to's. Under stable, secure military conditions the cooking may be done in a hut or lean-to, particularly in the mountainous region. Camp fires will be built outside of a hut if a hut exists.

c. Surrounding Environment: Guerrilla activity is not limited to tropical rain forests. Consequently the cooking stoves will be used in foliage ranging from 4 to 5 foot high scrub trees and brush to dense forests. Any foliage capable of furnishing protection from visual observation

can constitute surrounding environment.

d. Time of day of greatest fire activity: In the opinion of personnel queried, the time of greatest cooking activity is a 2 to 3 hour period centered around sunrise. However, it was stated that some guerrilla groups cook in the evening and that the activity covers a 2-3 hour period centered around sunset. Camp fires generally exist for about 4 hours starting at sunset.

e. Additional heat sources: No additional significant heat sources are believed to exist. Charcoal is stolen or confiscated by guerrilla troops in the delta regions. Troops in "safe" areas may process charcoal, but this is believed to be unlikely. No armament foundries are believed to exist other than individual use of a charcoal stove as a forge." (ref. 7.1)

7.2.2. Detection

Radiation from a campfire may be seen by an airborne sensor either along a direct path through an opening in a canopy or indirectly. Indirect detection may be possible of light reflected into the field-of-view of the sensor by foliage with favorable orientations. Also, if a portion of the canopy over the campfire is heated sufficiently, the presence of the campfire may be inferred by detection of the "hot-spot" as an unusual item in the background. In principle, it is even possible that a difference in transmission characteristics of the air due to accumulated combustion products, could be detected. Of these possibilities the most interesting, clearly, is direct detection.

It is absolutely certain that functioning current thermal mappers can detect fires and other similarly hot targets in direct viewing. Experience shows that a useful ratio of targets detected to targets present can be detected in fairly open cover.

The density of cover, type of equipment, and method of observation which allow relative certainty in detecting a useful percentage of targets are not known and can be deduced only in part.

Whether or not the presence of fires under cover can be detected without a direct look at the heat source is not known and can be inferred only in part on the basis of present knowledge.

A carefully planned program of experiments is needed to resolve these factors. The immediately following discussion points out the factors which must be considered and implies the type of experimentation necessary.

7.2.2.1. Direct

The factors that determine the success of direct detection are partly geometrical and partly physical in nature.

It is convenient to refer to the effect of obscuration by the foliage of the line of sight, as a geometrical constraint on detection. These conditions are treated in Section 7.3.

In the category of physical factors belong the radiative characteristics of experimental targets used in obtaining data on the geometrical factors, the radiative characteristics of tactical targets, the transmission characteristics of the paths of various transmissions, and the capability of detection equipments.

For a complete evaluation, the targets should be known in detail. The details are the spectral radiant intensity as a function of angle, time and size. An additional parameter for tactical targets is the configuration, that is, the fire (oven) and cooking utensil. The target characteristics---together with the path-transmission and equipment-characteristics---should facilitate a conversion of measured detection---probability of simulated targets to that of tactical targets.

The transmission-characteristics may be sufficiently established when the amount of water-vapor in the path and the length and slant-angle of the path is known. If the vertical profile in the target area, of the mixing ratio of water-vapor and temperature is known and is reasonably constant, the relative-humidity and temperature near the ground may be the only input necessary (in addition to the geometry of the path) for calculation of the path-transmission.

To evaluate experimental data obtained on fully viewed targets, data on the instantaneous field-of-view and aperture-area of the scanners should suffice because of the large target-signal to background-signal ratio*. On the other hand, the sensitivity of the various scanners and their spectral response must be accurately known to evaluate data from

*Assuming that the scanner has a $(4 \text{ mirad})^2$ instantaneous field-of-view with a uniform response between 3 and 5 microns, and the range to the 1100°K target of 14" diameter is 1 km, the ratio of the target signal to the total (dc) signal from a 300°K background is about 25, at identical emissivities of the target and background. This ratio decreases to about 7, in the spectral region between 8 and 12 microns, but rapidly increases in regions below 2 microns. However, the effective background signal, i.e., the variance of the background-radiation in the field of view, will be by orders of magnitude smaller than the total radiation. Consequently, we deal, at fully viewed targets, with very large signal to limiting-noise ratio.

partially viewed targets (i.e., when the angular size from the target of the effective opening is considerably smaller than that of the aperture). This need can be best fulfilled when the scanners are calibrated to the same source both before and after each mission. The calibration source could be a container filled with water of known temperature. The surface of water should be about four times as large as the area subtended by the scanner to assure that the surface completely fills the field-of view. As a substitute solution, a suitable area of a runway would be perhaps also sufficient to deduce the sensitivity of the scanners.

7.2.3.2. Indirect

In order to facilitate determination of detectability through an indirect path, the following input data should be available:

°Spectral reflectivity of foliage of tropical trees. These data are necessary for a judicious choice of the spectral region of detection of (multiple) reflected radiation.

Because the sensitivity required of an airborne scanner can be attained only in a relatively wide spectral region the necessary spectral resolution---except in the visible region--- of the measurements would be low and roughly determined by the atmospheric windows below about 3.5 microns. This limit appears probable because of the relatively strong self-emission compared to the reflected radiation that seems likely to exist at longer wavelengths. Final judgment of this aspect is possible only with reasonably detailed data of the discussed type on hand.

Probability that a given fraction of radiation emerges through (multiple) reflection from the jungle-top. These data may be regarded as complementary to the characteristics of opening geometry when disregarding spectral reflectivity and target intensity. In this case, the emerging radiation is a function of foliage-size and relative orientation. This geometrical characteristic could be perhaps obtained by measurements in one spectral region chosen when the spectral reflectivity is known. The difficulty in performing such measurements, is that---in contrast to the measurement of the opening geometry of a canopy---a point source has to be used, the jungle-top has to be mapped and also, discrimination must be made between reflected and direct radiation through openings. The most practical technique is perhaps a two-color mapping of the jungle-top but no simple method is envisioned that would readily assure attainment of the objective. This is so because of the need to distinguish between reflected and direct signals. While this may be easily achieved at large direct signals coming through large openings, discrimination between low-level signals could be extremely difficult unless the reflected signal always comes from a large area whereas the direct signal is the smaller, the smaller the opening is.

Vertical temperature-distribution and horizontal extent of isotherms above a continuous fire of known intensity. These

relatively easily obtainable data are necessary to determine the possible existence of a measurable temperature rise of the top foliage due to heating by the fire*.

° Temperature map of top foliage. Once the possibility of a temperature rise has been deduced from measurements mentioned before, an attempt to detect this rise could be best made by means of an airborne thermal mapper having a field-of-view matched to the spatial extent of the temperature rise.

° Amount and concentration of combustion products emerging from the jungle.

° Natural variation of the spectral radiance of jungle-top--
Data needed to establish the magnitude of the "background noise" both in direct and indirect detection.

7.2.3. Forestry Service Program

In July 1962, it was found that the Northern Forest Fire Laboratory, Missoula, Montana (U. S. Dept. of Agriculture) had begun a small experimental program (ref. 7.2) funded by OGDH, to evaluate the utility of IR techniques in detection of forest fires. The program is under the direction of Mr. Stanley Hirsch, Northern Forest Fire Laboratory, Missoula, Montana, Telephone: Area Code 406, 543-5167.

The experiments are carried out in the Missoula forest area using an AN/AAS-5 thermal mapper on loan from the Signal Corps, mounted in a Twin Beechcraft serviced by Johnson Aircraft.

Fires are simulated by burning charcoal in 1- or 4-square ft. drum containers (10" and 24" buckets of glowing charcoal) at a surface

*This type of measurement has been made in Operation Tropicana but the results are unknown to us.

7.2 U. S. Department of Agriculture, Forest Service, Intermountain Forest and Range Experiment Station, Ogden, Utah, Research Note No. 91, May 1962

Table 7.2.1

CHARACTERISTICS OF SELECTED SITES

SITE I		SITE II	
Species	Ponderosa pine	Species	Ponderosa pine
Size class	Small pole	Size class	Saplings-small pole (straggler)
D.B.H.*	4-10 inches	D.B.H.	2-6 inches
Height	20-50 feet	Height	20-30 feet
Live crown ratio**	30-50%	Live crown ratio	30-50%
Aspect	South-east	Aspect	South-east
SITE III		SITE IV	
Species	Ponderosa pine-Douglas fir	Species	Douglas fir
Size class	Pole Stand	Size class	Small low timber
D.B.H.	8-12# inches	D.B.H.	2-18 inches
Height	20-60 feet	Height	12-70 feet
Live crown ratio	50-70%	Live crown ratio	20-60%
Basal Area***	70 sq ft/acre	Basal Area	50 sq ft/acre
Aspect	North-east	Aspect	East
		NOTE: This is the only Douglas fir stand and this may account for some of the low per cent of openings.	

*Diameter at Breast Height.

**Ratio = height of live crown to total tree height.

***Sq ft wood at tree base/acre--- common forestry measurement.

~~SECRET~~

7.2 Operational Test

7.2.1 Introduction

Operation Tropics--the Aerial Sensing of Tropical Surfaces--was conducted by the Photographic Interpretation Research Division of the U.S. Army Cold Regions Research and Engineering Laboratory (CRREL) of the U.S. Army Materiel Command with contract to University of Michigan. Its primary purpose was the development of multiband sensing techniques for obtaining data on (1) remote tropical surface features (soils, rocks, vegetation, etc.) and prediction of behavioral characteristics and (2) evidences of military activity against various backgrounds (vehicles, equipment, personnel, etc.). The operation was conducted in November 1962 in Puerto Rico. The tasks included (a) a literature and airphoto study (b) the location and utilization of one or more pilot study areas representing a variety of tropical backgrounds (c) the installation of special targets and (d) the conduction of coordinated air/ground aerial sensing missions (night, day, diurnal monitor, scale, detector type, etc.) and (e) the preparation of a comprehensive report with recommendations.

On August 1, 1962 a meeting was held at ARPA's request to discuss the possibility of a piggy-back, no major interference, experiment, during the Tropics exercise. A DRC observer attended and discussed relevant experience. It was agreed at the meeting that fire-detection experiments would be carried out under the direction of Mr. Robert Frost (CRREL, Box 282, Hanover, New Hampshire, Telephone; White-River Junction, Vermont, 802-295-3415) and that a DRC representative would take part as a technical observer.

Plans for IR instrumentation were described as follows: Two IR scanners were to be simultaneously operated with instantaneous fields-of-view

~~SECRET~~

of 1 mrad and 6 mrad, and an intermediate size as desired. An InSb (2μ - 6μ) detector would be used for relatively high temperature radiation and a Ge (8μ - 13μ) detector for radiation at ambient temperature. The spectral range could be further limited by filters to the regions between 3 and 4 microns and between 4.5 and 5.5 microns; furthermore, another filter was to be available that somewhat narrows the 8μ - 13μ region to exclude the edges of this window that is sensitive to variations of absorber concentration in the optical path.

By keeping the various detector packages pre-voled during a mission a scanner could be changed in flight in about one or two minutes to obtain a desired field-of-view spectral-response combination. Thus, it would be possible to map the same target field with various spatial resolutions and in various spectral regions, under practically invariant conditions. At an instantaneous field-of-view of 1 mrad, a temperature sensitivity of better than 0.1°K is expected in the region between 2 and 6 microns and, better than 0.05°K is expected between 8 and 13 microns for ambient temperature targets.

The information was to be recorded on 70 mm photographic film and on magnetic tape. (The tape is very important as it facilitates the investigation of various data processing techniques for optimum evaluation of the obtained information.)

A single channel radiometer with either Ge-Cu or InSb detector, in connection with a chart recorder, would obtain quantitative data on the temperature of the terrain directly underneath the airplane. The instrumentation also was to include a K-17 aerial camera and an f-m communication link to ground.

During the meeting Colonel A. J. Gondfellow (AFCIN-104) reported on experience of Air Force Intelligence reconnaissance in Southeast Asia. A Reconofax VI has been used (and operated satisfactorily) in conjunction with photography and radar (L-band). The IR and high resolution radar did not produce much information but did improve overall seeing somewhat. [On one occasion a boat in the shade of a bridge was seen with IR while invisible on photograph.] Neither sensor gave much data on ground under canopy.

The DRC observer suggested use of a shorter wavelength spectral region at dusk and in night-time missions in order to increase the fire signal-to-background ratio. Mr. B. Lyle Hanson (CRREL) suggested passive microwave radiometer measurements. Neither suggestion was adopted.

7.2.4.2. Planning

In October the following general information on plans was obtained from CRREL by telephone:

The target-area selected was in the Luquillo National Forest (also called Luquillo Recreational Area) about one-hour drive from San Juan, Puerto Rico. This area is mountainous and contains rain forest believed to be similar to those found in S.E. Asia. Unfortunately, the rain-forest is on mountain slope making the geometrical situation for mapping unfavorable. For reasons of safety, the minimum altitude above the targets might be as much as 3000 feet. However, the selected area facilitates the placement of targets under various canopies ranging from the completely open to the extremely dense.

Plans included establishing the characteristics of canopy and measurements were to be made of the daytime illumination at selected places.

It was also planned to measure the vertical temperature distribution above the fires up to 200 feet if possible, by means of balloon-mounted temperature probes (thermocouples or thermistors).

The targets would be smoldering charcoal, about 10 or 12 lbs in baskets of 14" - 15" diameter. The surface-temperature of the charcoal is estimated about 1100°K. (These targets very closely resemble those used by the Forest Fire Laboratory, Missoula, Montana.) The power distribution from the targets was expected to be Planckian, and "quite a number" of them were to be used simultaneously.

In addition to the University of Michigan's plane, three Air Force planes from Rome Air Development Center would participate in the mapping, as arranged by Major Yarbrough. The airplanes would fly, per mission, a number of passes at various altitudes in order to include as many different "looks" as possible in the practice. No other data were obtained prior to the exercise.

7.2.4.3. Experiment

A DRC observer viewed the experiments from 10 - 18 November, during which roughly half the planned missions were flown. His report of mid-November is given below:

a) The Environment

The target region is in the tropical rain forest of the La Mina Recreational Area that is a part of the Luquillo Division of the Caribbean National Forest, some twenty miles East of San Juan, Puerto Rico. The terrain is mountainous with peaks as high as 3500 feet. The rain forest receives an annual rain fall of more than 200 inches that falls in about 6 per cent of the total time. During the wettest months of the year (March and November), rain

can be expected in four out of five days. The average daytime temperature in the forest is about 80°F; the average temperature at night is about 70°F. The average relative humidity is more than 90 per cent. Under these conditions, tropical trees grow with amazing rapidity: it is said that more than 300 species have been identified. Perhaps the most frequently encountered species are the Sierra Palm (*Euterpe Globosa*), the Weatherwane tree (*Cecropia Peltata*), the giant fern trees that reach a height of 30-40 feet, and the tallest tree, the Tabonuco (*Dacyodes Excelsa*). The average diameter of trunks is perhaps one foot; the average separation of trees is on the order of 15 feet. The height of the forest is about 100 feet.

The stand of the rain forest selected for the primary target area is along the "La Mina" trail, at an elevation of about 1500 feet, in the valley of the La Mina River. The trail leads parallel to and about 20 or 30 feet above the river bed.

The portion of the trail--perhaps one quarter of a mile long--along which the targets were placed, has not been used for perhaps a few years. In order to make it passable, especially at night--test personnel had to clear it of overgrowth. Moreover, the equipment and supply had to be handcarried, an accomplishment that can only be appreciated by an eyewitness. (For instance, a heavy rain once carried away a large part of the supply of charcoal.)

b) Plans for the Experiment

[Perhaps because of the extreme effort required by these activities, the DRC observer was given only a cursory briefing concerning the plans for the experiments and was able to find out about the status of the experiments only occasionally.] According to the cursory briefing commercial water buckets

filled with burning charcoal were to serve as targets. These targets constitute a nearly-black-body source at about 1100°K . for a period of time of 6 to 8 hours. During the experiments, the source intensity was to be periodically monitored by portable radiometer. The canopy above each target was to be photographed to facilitate determination later on in the laboratory, of the canopy characteristics.

In addition, plans called for measurement of the following quantities: soil temperature; air temperature, relative humidity; wind velocity; vertical temperature distribution above selected targets; typical vertical temperature distributions in the stand without target; sky brightness; and level of illumination in the stand. A scientific description of the stand and terrain was to be reported by a botanist and a geologist, respectively.

It was planned to obtain images from the air of the primary target area (and of two other areas without targets; - one of the wettest and another of the densest stand of the forest) in the 3 to 5 micron region (InSb detector) and, in the 8 to 13 microns region (Cu and Hg doped Ge detectors) by means of a modified AN/AD-2 and AN/AR-9 line scanner mounted in an R4D aircraft. These scanners can be operated simultaneously except when one of them is being replaced by a K-17 camera. The instantaneous field of view of the scanners depends on the size of the detector in use. Either a nominal $(2 \text{ mrad})^2$ or $(4 \text{ mrad})^2$ field of view can be achieved. The scan field of the scanners is 120° and 60° respectively. The signal from the scanners was to be recorded on magnetic tape and on photographic film. The photographic records were to be developed after each emission; the tape recordings are destined for detailed evaluation in the home laboratory. A chopper radiometer has been installed in

~~SECRET~~

the aircraft with an instantaneous field of view and spectral response which can be selected to match the scanners. The radiometer was to measure the absolute irradiance from a strip of the target area directly underneath the airplane. Thus, by correlation, irradiance values from the entire scan field may possibly be determined in the home laboratory.

c) Preliminary Results

It has been observed that the limited rate of climb and descent of the airplane prevented low-altitude flights (less than about 1500 feet above the target area), while low-lying clouds masked the mountain peaks during a large fraction of the time. As a consequence of these conditions, the airplane was in flight less than a total of 12 airborne hours--out of the planned total of 26 hours--from Wednesday noon until Sunday evening (19th of November). Even so, the airborne time often failed to result in imagery because of unsuccessful attempts in breaking through the cloud cover. Altogether, a dozen passes resulted in IR images. A cursory inspection of these records revealed only two "hot spots". One hot spot seemed to appear invariably in the records; this was impossible to quickly identify, but the invariant appearance pointed to a source located in an open area not identified in test plans at this time. The other hot spot could have been a target, located perhaps on a foot bridge across the river, that is also in a rather open area. If this quick assessment is correct, not one of the 12 targets under heavy canopy has been detected with a sufficiently high signal for a ready identification.

7.2.4.4. Critique

It appeared at this time that the experimental results confirmed DRC expectations of not seeing many of the targets under very dense

canopy. [Since this time, verbal reports indicate that subsequent missions saw a large fraction of targets, a circumstance which is difficult to reconcile with the earlier missions and probability calculations if the cover was indeed dense. Since the Tropical report is not yet available the solution to this mystery is unknown.]

Detailed plans for instrumenting and laying out the experiment were not made available to DRC and hence could not be criticized. As nearly as can be determined no statistical analysis of the experiment was made in the planning stage.

Subsequent information is that, based on the verbally reported very good results, there is high enthusiasm for the technique as a possible ready tool for use in Vietnam, for pinpoint reconnaissance.

It is the Contractor's opinion that considerably more and careful local experimentation should precede any commitment to an operational experiment. It is clear that fires can be detected under certain conditions. It is certain that not enough experience is in hand to define the reliability of detection. Further, the Contractor believes that detection can be improved markedly by a relatively easily-developed equipment optimized for this purpose. It is possible with such equipment, hunter-killer missions might become feasible. These matters are dealt with in greater detail in 7.3.

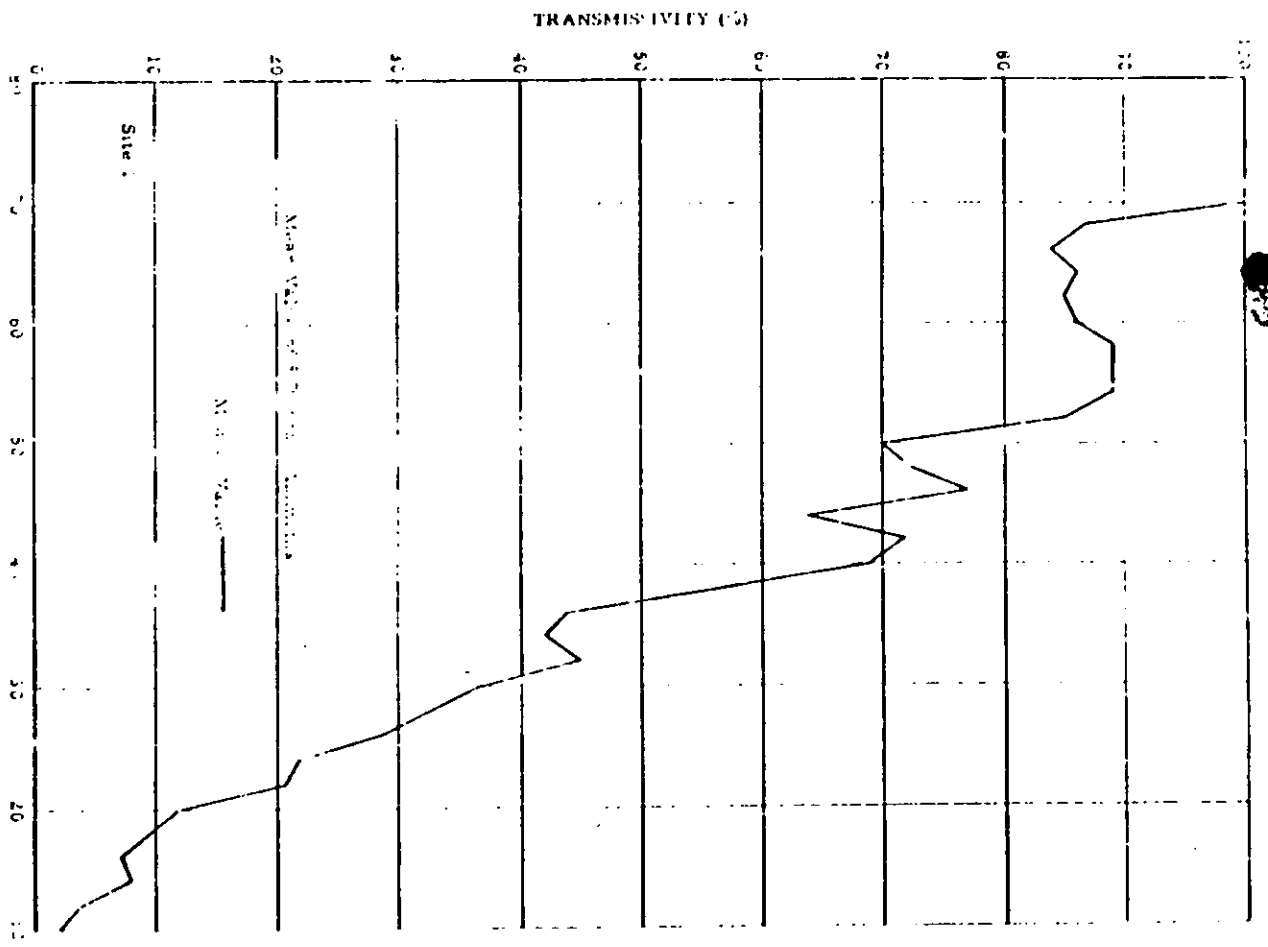

VELOCITY ANGLE
Figure 7.2.1

-7.37-

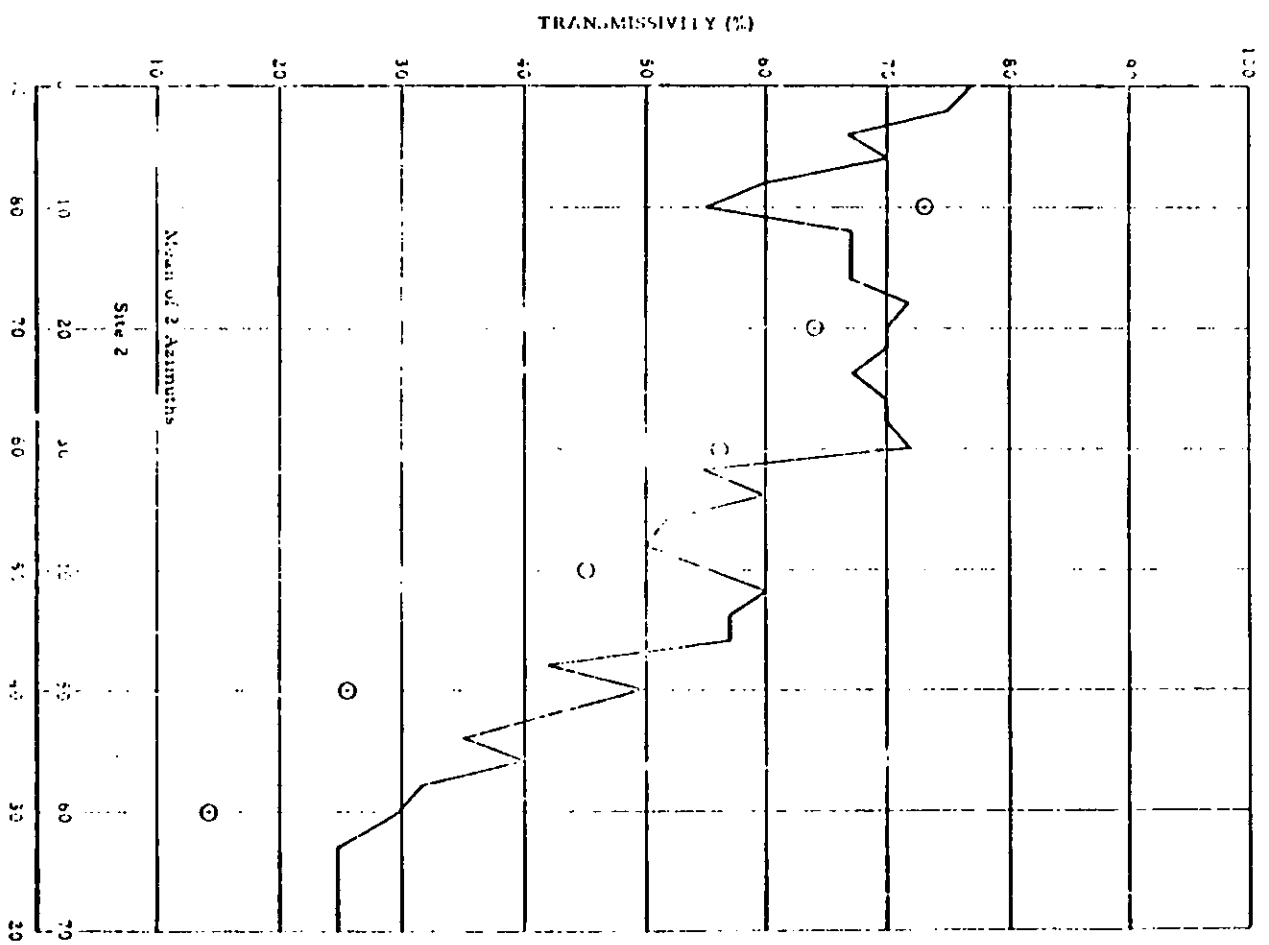

TRAIL GIBBERELIN (%)

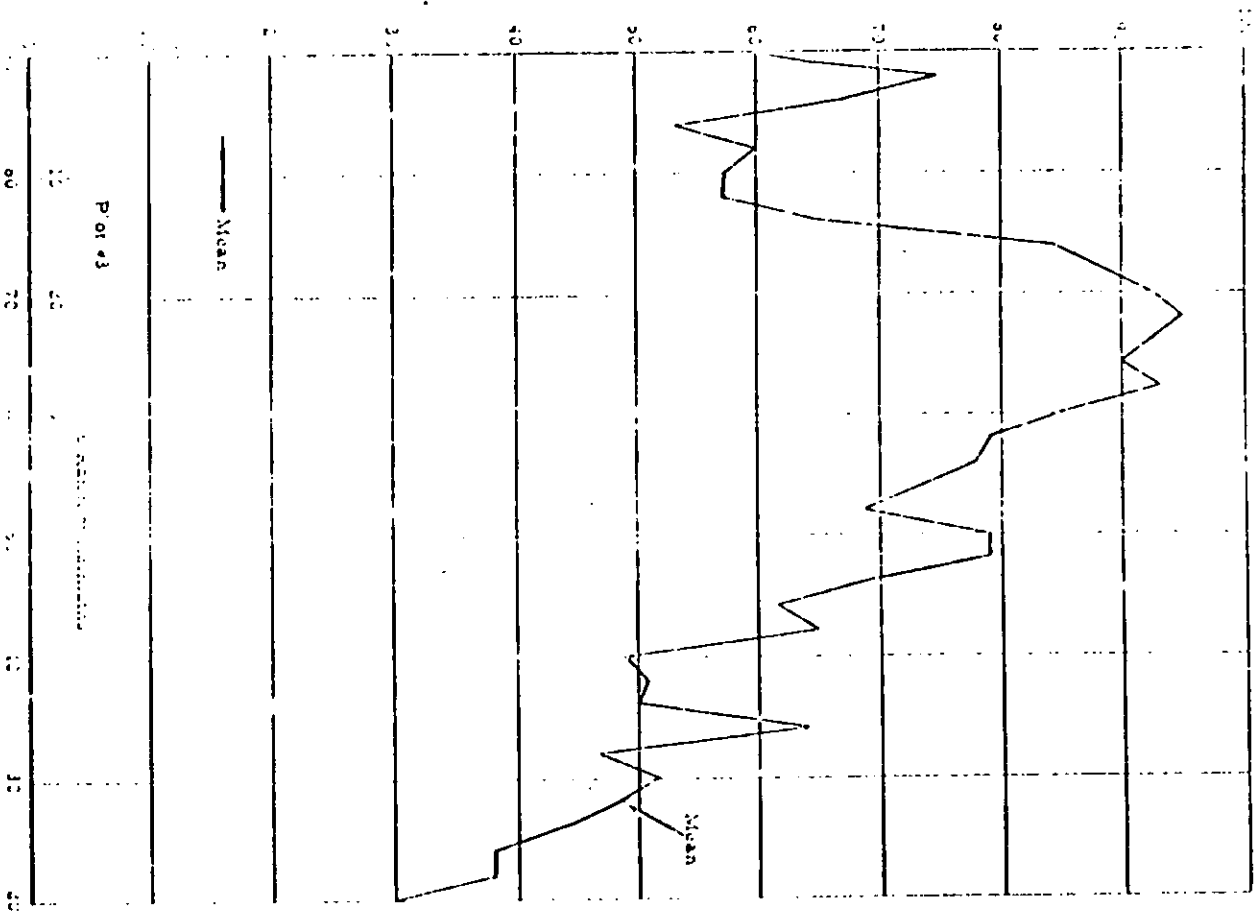

TRAIL GIBBERELIN (%)
Figure 11-213

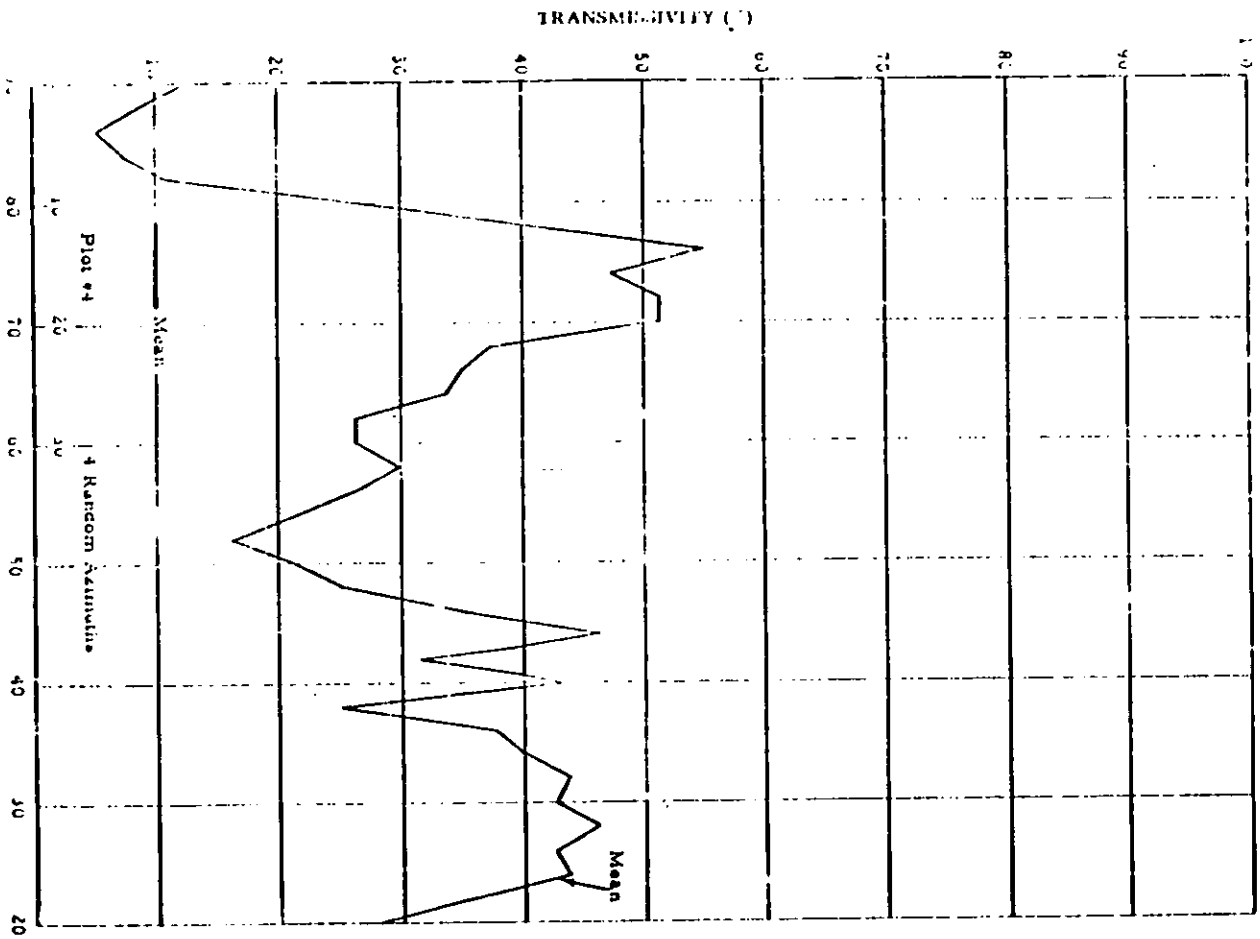

VERTICAL ANGLE
Figure 7.2.4

~~SECRET~~

7.3 PROBABILITY CONSIDERATIONS AND NEW EQUIPMENT FOR FIRE DETECTION

A probabilistic consideration of finding unobscured lines-of-sight to the targets, and, an outline of the pertinent features of an equipment tailored to the conditions described herein.

CONTENTS

- 7.3.1 Introduction
- 7.3.2 The Geometrical Conditions of Detection
 - 7.3.2.1 Definition of conditions and terminology
 - 7.3.2.2 Elements of probability used in the investigation
 - 7.3.2.3 The probability of seeing targets under canopy
 - 7.3.2.4 Some specific numerical examples
 - 7.3.2.5 Conclusions
- 7.3.3 Outline of the Features of an Airborne Equipment Tailored to the Geometrical Conditions of Seeing
 - 7.3.3.1 Scanner
 - 7.3.3.2 Recorder
 - 7.3.3.3 Some aspects of feasibility
 - 7.3.3.4 Conclusions
- 7.3.4 Summary

7.3.1 Introduction

A canopy may be defined as the entity of opaque objects of some shape, in random distribution above a target field. Depending on the configuration of the projected areas of the objects, a canopy may cover the targetfield in various degrees between complete coverage and no coverage at all.

Thus, detection of a target under a canopy is dependent on "geometrical conditions" imposed by the canopy, as well as on "physical conditions" such as the radiant intensity of the target, range, sensitivity of an equipment,

~~SECRET~~

etc. We refer to the fulfillment of the geometrical conditions as "seeing the target," in contrast to the simultaneous fulfillment of the geometrical and physical conditions which leads to the "detection of the target".

The first part of this paper is devoted to the derivation of analytical expressions of the chance that one has -- limited because of the geometrical conditions -- of seeing a point target from the air. The second part presents the pertinent features of an airborne equipment tailored to the geometrical conditions.

Although occasioned by the fire detection problem the treatment given here is general and elementary details are included to promote easy reading. However, the entire problem must be considered in reference to pertinent information in 7.1.

7.3.2 The Geometrical Conditions of Detection

The objective of this portion of the paper is the determination of the probability, under various conditions, of seeing a target. It is convenient to define the conditions and the terminology to be used as follows:

7.3.2.1 Definition of Conditions and Terminology

We consider two generally distinct conditions:

Condition 1

- a) There are a number of identical targets randomly placed under a canopy. The location from which the attempt is made to see these targets, is called the "point of looking."
- b) Consider solid angles, centered on the radii between the targets and the point of looking, with apices at the point of looking.

SECRET

These solid angles of identical absolute value will be called (one at a time) instantaneous field of view (= i.f.v.). The i.f.v. is limited at the lower extreme by the criterion that the area subtended of a target must be much less than the i.f.v. subtended area (i.e., the target is a "point" target). It is limited at the upper extreme by the requirement that the i.f.v. never include more than one target.

- c) Targets will be considered "seen" if they are viewed at the aspect of "half-moon" or "more-than-half-moon"; they will be considered not seen if they are viewed at less than half-moon. An additional simultaneous condition is that an area around the point of looking subtended from the target by a solid angle of the order of magnitude of the target's from the point of looking, is seen at least as a "half-moon".
- d) The point of looking is taken random within the total solid angle with apex at the target, in which a canopy exists. We call this solid angle the "angle of hiding".
- e) The "field of search" for a target is restricted to the angle of hiding inverted so that its apex coincides with the point of looking.
- f) An elementary area seen by the i.f.v. in the field of search is investigated for target only once, at a "look angle" that is taken randomly in a vertical plane through the point of looking. However, the randomness of the look angle is taken to be identical to the randomness in space of the point of looking, so that fixing one determines the other.

g) The point of looking is taken to move with constant velocity at constant altitude, and the look angle is taken to run through the intersection of the cone determined by the field of search, and the plane perpendicular to the velocity vector of the point of looking. The angular velocity of the look-angle's running leg is taken high relative to the velocity of the point of looking, so that the point of looking appears stationary during the time (called line-time) the look-angle runs through its range.

Condition 2

- a) The measure of a canopy is its average density (\bar{c}) which is defined as the ratio of the integrated solid angles from target subtended by the opaque objects in the angle of hiding, to the angle of hiding.
- b) The canopy within the angle of hiding is taken to be homogeneous.
- c) The degree of homogeneity is taken to be such that in any strip of angular width = component of i.f.v., parallel to the velocity-vector, the canopy density is the same as it is in the entire angle of hiding.

Under these conditions there are three cases of particular interest; the point of looking at any given instant may or may not be in a vertical plane that goes through the target and is perpendicular to the velocity-vector; the point of looking may or may not be in an unobscured line of sight; and the look angle's running leg may or may not sufficiently coincide with the radius vector, to fulfill the condition of half or more moon. The three cases represent, however, only one random condition of seeing, because:

~~SECRET~~

- o The point of looking has been, or will be at some other time -- for the duration of one line time -- in a vertical plane, according to condition 1(g).
- o The coincidence of the look angle's running leg with the radius vector to the point of looking, and the latter being in an unobscured line of sight are identical criteria, for the point of looking is taken stationary for the duration of a line time. That is, once the point of looking is in an unobscured line of sight the running leg of the look angle will definitely coincide with the radius sector at some "instant" during the line time.

Consequently, the probability of seeing a target from the point of looking equals the probability that the sky (to the extent defined in 1(c)) will be seen from the target in any randomly chosen direction within the angle of hiding. The derivation of this probability is found in subsequent paragraphs. First, however, the mathematical tools used in the derivation will be summarized.

7.3.2.2 Elements of Probability

The treatment of the present problem has been based on the following elements of probability.

The probability V that an event E occurs is defined as the ratio of the number, k , of favorable possibilities to the number, I , of all the possibilities*:

$$V = \frac{k}{I}$$

*For example, E might be an act of drawing-blindfolded--one of k red marbles out of an urn that contains $I-k$ additional blue and/or green marbles.

~~SECRET~~

~~SECRET~~

~~SECRET~~

Thus, the probability is a real fraction, the limits of which are:

$V = 1 = \text{Certainty}$ and,

$V = 0 = \text{Impossibility.}$

Moreover, since it is certainty that an event either occurs or does not occur, the probability that the above event will not occur is $1 - V$.

From the above definition, the following relations of interest to us for the present problem follow:

a) The Probability that All of n Independent Events Occur

Considering just two events for the moment, the probability V' that both the independent events E_1' and E_2' , of respective probabilities v_1' and v_2' occur, is $V' = v_1' \times v_2'$. For, when the events are completely independent, all the cases that are possible for E_1' can combine with all the cases possible for E_2' , resulting in $l_1' \times l_2'$ possible cases. Similarly, all the cases k_1' that are favorable for E_1' can combine with the k_2' favorable case that prevail for E_2' , resulting in $k_1' \times k_2'$ favorable cases. Thus,

$$V' = \frac{k_1' \cdot k_2'}{l_1' \cdot l_2'} = v_1' \cdot v_2'.$$

In general, for n events (omitting the upper index):

$$V = \prod_{x=1}^n v_x \quad (I)$$

~~SECRET~~

b) The Probability that Either One of n Mutually Exclusive Events Occur:

Let k_1'' denote the number of favorable cases of event E_1'' , k_2'' denote the favorable cases of E_2'' and l'' denote all the possible cases, then the probability V'' that either one of the favorable events occurs, is

$$V'' = \frac{k_1'' + k_2''}{l''} = v_1'' + v_2''$$

In general, for n events (omitting the upper index):

$$V = \sum_{x=1}^n v_x \quad (II)$$

c) The Probability that At Least One of n Independent Events Occur

The possible combinations of the independent events E_1''' and E_2''' of respective probabilities v_1''' and v_2''' are:

Favorable: $v_1''' (1 - v_2''')$; $v_2''' (1 - v_1''')$; $v_1''' v_2'''$ and,

Unfavorable: $(1 - v_1''') (1 - v_2''')$.

Since the sum of all the combinations equals unity, the difference between unity and the sum of the unfavorable combinations (which is the sum of the favorable combinations) is the sought probability, V'''

$$V''' = v_1''' + v_2''' - v_1''' v_2'''$$

*An example of mutually exclusive events is the drawing of a red or white marble from an urn that contains marbles of blue and/or green as well as red and white.

In general, for the case of n events (omitting the upper index):

$$\begin{aligned}
 V &= \sum_{x=1}^n v_x - v_n \sum_{1}^{n-1} v_x + v_n v_{n-1} \sum_{1}^{n-2} v_x - \dots \\
 &= \prod_{2}^n v_x - \sum_{1}^2 v_x + \prod_{1}^n v_x \quad \text{(III)}
 \end{aligned}$$

where the odd numbered terms are positive and the even numbered terms are negative.

In addition to the relations above, it may be recalled that the calculus of probability is really useful only when there are a very large number of cases at one's disposal for evaluation. For instance, in flipping a coin 6 times, the expectation is that heads will come up 3 times; nevertheless, not always will three heads come up when repeating this process of 6 flips in a row. As a matter of fact, the deviation from the predicted number of heads may occasionally be extreme: it is quite probable that no head will come up at all in six consecutive flips. However, making the process in groups of not 6 but 100 flips, heads will come up 50, perhaps also 48, 53, 52, 49, 47, 51, times, in any case the number of times when heads will come up will not differ very much from $1/2$ of the total number of attempts. In other words, the law of large numbers says that

o only in sufficiently large number of attempts will the number of actually occurring events, begin to approach the product of (number of attempts) x (average probability), and

SECRET

o a predicted result can be achieved with certainty only at the limit of an infinite number of attempts.

By this fact, an apparent paradox becomes clear: Let us assume that in the process of flipping a coin, 10 times in a row tails come up. Through a hasty consideration one might expect that head is more probable for the 11th attempt. But, what mysterious force should act because of the outcome of the previous events, to cause heads to come up next? Such a force does not exist except for Aladdin's jinni or a dubious gambler, and the eventual assumption that "for compensation now a head must come," is completely false: for, only an extremely large number of attempts can result in a "compensation," i.e., can lead to a value that equals the probability times the number of attempts.

The law of large numbers can be used 'a posteriori' to ascertain from observations (such as percentage death at various ages) certain probabilities (such as past life expectancy) by means of which one can derive--through combinations with other probabilities (such as advances in medicine, improved living conditions)--new probabilities (such as future life-expectancy). It will be seen that it is essential to have a statistically valid base (i.e., reasonably large numbers) in experimental verifications, or predictions will be very shaky.

We shall close our recollection on the general interpretation of statistical data, with a reference to the typical application of probability to corpuscular phenomena in physics. Here the integral effect of corpuscula are accurately described by means of statistical laws, for -- at the very large numbers of atoms usually involved in related phenomena -- the

SECRET

law of large numbers almost always applied so well that statistical relations assume the strict character of a natural law. When experimental observations can be restricted to a relatively few atoms (or, theoretical calculations are being made for a relatively few atoms), only then are deviations from the prediction of average probability (i.e., fluctuations) first noticeable, indicating that the realm of random phenomena has been entered. Deep in this realm one hardly sees anything else but fluctuations (noise).

Because of limitations in the practice (in an experiment, for instance), the range of attempts realistic to consider in the present case, leads us into the very random region of the effect of geometrical conditions. This situation calls for a careful interpretation of the conclusions to be drawn, especially when a comparison to a very small sample of actual data is being attempted. Nevertheless, with proper care, information of great value can be deduced even in this case as will be seen from the discussion to follow.

7.3.2.3 The Probability of Seeing Targets Under Canopy

The average probability, \bar{P} , that a target under canopy of the average density \bar{c} , will be seen in any one attempt, is

$$\bar{P} = 1 - \bar{c} \quad (1)$$

Then, the average probability of the specific event that at least one of N targets will be seen in any one attempt, $\bar{P}(\frac{1}{N})$ is

$$\bar{P}(\frac{1}{N}) = 1 - (1 - \bar{P})^N = 1 - \bar{c}^N \quad (2)$$

because -- under the conditions defined in the first paragraph -- the event

~~SECRET~~

of seeing one target is completely independent of the event of seeing in the same attempt another target.

Equation (2) is shown evaluated in Figures 7.3.1a, and 7.3.1b.

In Figure 7.3.1a, the probability $\bar{P}(N)$ vs N is shown at various values of \bar{c} as parameter. Figure 7.3.1b shows N vs \bar{c} with $\bar{P}(N)$ as parameter. As it is implicitly seen in the figures, the following conclusion of particular interest from a practical standpoint may be drawn from Equation (2):

- o The rate $\frac{\partial \bar{P}(N)}{\partial N} = \bar{c}^{-N}$. In \bar{c} ($\bar{c} < 1$) at which the probability $\bar{P}(N)$ increases with the increase of the number of targets, is decreasing with increasing number of targets.
- o The rate is higher at higher \bar{c} than it is at lower \bar{c} .
- o The rate is high first (linear region) then it becomes increasingly lower and lower with increasing number of targets (asymptotic region).
- o The relative gain in probability that can be obtained when instead of one target a large number of targets is used, is much higher at high canopy-density than it is at low density.
- o The rate $\frac{\partial \bar{P}(N)}{\partial \bar{c}} = -N \cdot \bar{c}^{-N-1}$ at which the probability decreases with increasing canopy-density, is the smaller the larger is N.

Consequently, the number of targets necessary to maintain a preset probability (a probability of 1/2, for instance) is heavily dependent on the canopy-density. Even if it is impractical in case of high canopy-density, to assure a desired probability, the number of targets should be

~~SECRET~~
-7.51-

made as high as possible, increasing it to a point, for instance, where the deviation from the maximum (initial) rate (at low N) is not more than a practical value, such as might be 10%. With other words, the number of targets to be used in an experiment should be determined by the average canopy-density: the number should be high when the canopy-density is high and could be but decreased in case of canopies of lesser density; but -- unless there was some other over-riding aspect -- should not be done in the reverse. These considerations appear especially significant in view of the fact that a really meaningful evaluation of detectability, based on experimental data, cannot be done without, because of the very nature of the involved phenomena, a large number of samples.

In a slight detour, let's consider next the N targets distributed under various canopies within the density range between \bar{c}_a and \bar{c}_c . Then, with

Q = number of targets under canopy of the density-range between \bar{c} and $\bar{c} + d\bar{c}$,

q_i = number of targets seen through canopy i.

\bar{q} = average number of targets seen

$$\bar{q} = \int_{1-\bar{c}_a}^{1-\bar{c}_c} Q(\bar{P}) \bar{P} d\bar{P} = \bar{q} \quad (3')$$

In words, \bar{q} targets out of the total of

$$N = \int_{1-\bar{c}_a}^{1-\bar{c}_c} Q(\bar{P}) d\bar{P} \quad (3'')$$

~~SECRET~~

targets will be seen (in any one attempt) where P is as given by Equation (1)

Since it is of great importance to determine the effect of variations in canopy density, which certainly occur in the real world, we can define from the relation of $q = (1-\bar{c})N$ an equivalent canopy density

$$\bar{c}_e = 1 - \frac{\int_{1-\bar{c}_a}^{1-\bar{c}_b} Q(\bar{P}) \bar{P} d\bar{P}}{\int_{1-\bar{c}_a}^{1-\bar{c}_b} Q(\bar{P}) d\bar{P}} \quad (3)$$

For instance, the targets may be distributed in various manners as shown for $\bar{c}_a = 1$ and $\bar{c}_c < 1$ in Figure 7.3.2* below:

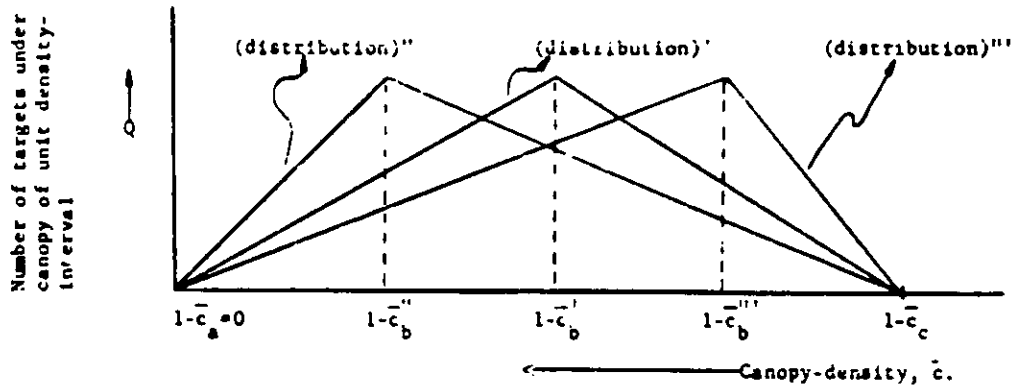

Figure 7.3.2. Illustrative distributions of targets under canopies of various densities.

Then, using the notations of $1-\bar{c}_b = b$, $mb = Q_b$ and $1-\bar{c} = x$ and, for (distribution)'

*Note that Q is as defined before and is shown versus $1-\bar{c}$, instead of versus \bar{c} .

~~SECRET~~

~~SECRET~~

in the figure, when $2(1-\bar{c}_b) = 1-\bar{c}_c$

$$\bar{c}_e = 1 - \frac{\int_0^{b'} m' x^2 dx + \int_{b'}^c (cm'b' - m'x) x dx}{\int_0^{b'} m' x dx + \int_{b'}^c (2m'b' - m'x) dx} = 1 - b'$$

In case when $3(1-\bar{c}_b) = 1-\bar{c}_c$

$$\bar{c}_e = 1 - \frac{\int_0^{b''} m'' x dx + \int_{b''}^c \left(\frac{3m''b''}{2} - \frac{m''}{2}x\right) x dx}{\int_0^{b''} m'' x dx + \int_{b''}^c \left(\frac{3m''b''}{2} - \frac{m''}{2}x\right) dx} = 1 - \frac{4}{3} b''$$

And, in case when $3(1-\bar{c}_b) = 2(1-\bar{c}_c)$

$$\bar{c}_e = 1 - \frac{\int_0^{b'''} m''' x^2 dx + \int_{b'''}^c (3m'''b''' - 2m'''x) x dx}{\int_0^{b'''} m''' x dx + \int_{b'''}^c (3m'''b''' - 2m'''x) dx} = 1 - \frac{1}{3} - \frac{127}{46} b'''$$

At the values of $b' = 0.15$, $b'' = 0.10$ and $b''' = 0.20$.

$$\bar{c}_e = 0.850, \quad \bar{c}_e = 0.66, \quad \text{and} \quad \bar{c}_e = 0.815$$

~~SECRET~~

[REDACTED]
SECRET

These examples numerically show the obvious fact that the equivalent canopy-density is the larger the more the distribution in a given density range favors denser canopies. When the distribution is symmetrical, the equivalent density is the arithmetic mean of the extremes of the density-range.

Furthermore, it seems likely that, a relation derived for a given canopy-density may be used for the same number of targets under a range of canopies when the distribution is such that the equivalent density in Equation (3) equals the given density.

Thus, the effect of placing in a given distribution a number of targets under various canopies can be evaluated in a simple manner. We will omit in the future the subscript g but will always mean equivalent canopy-density.

The main interest concerning the effect of the geometrical conditions, is a general expression of the probability of seeing, in any one or more attempts, at least a certain ^{*} fraction of any number of targets under a canopy of various densities. This expression may be derived as follows:

In case of N targets, each of the average probability of seeing as given in Eq. (1), an attempt may consist of the particular assembly of seen targets (all of these denoted with s because the targets are not distinguishable) and targets not seen (denoted with f) as follows:

$$\begin{array}{cccccccc} \overset{1}{\underbrace{\quad}} & \overset{2}{\underbrace{\quad}} & \overset{3}{\underbrace{\quad}} & \overset{4}{\underbrace{\quad}} & & & \overset{N-1}{\underbrace{\quad}} & \overset{N}{\underbrace{\quad}} \\ b & f & f & s & . & . & s & s \end{array}$$

^{*} leading to an integer number of targets.

For a number of sightings, of exactly k , the average probability that this event, in an assembly as above occurs, is

$$\bar{P} \binom{k}{N-k} = \bar{P}^k \cdot \bar{c}^{N-k}$$

However, k sightings could also occur in another assembly of successes (sightings) and failures such as:



Altogether, there will be $N!$ assemblies. But, $k!$ assemblies will be indistinguishable because the targets are indistinguishable and, $(N-k)!$ assemblies will be indistinguishable because the failures are indistinguishable. Consequently, there will be $N!/k!(N-k)!$ different assemblies and, the average probability of seeing exactly k targets in an attempt, $\bar{P} \binom{k}{N}$ is

$$\bar{P} \binom{k}{N} = \frac{N!}{k!(N-k)!} \cdot \bar{P}^k (1-\bar{P})^{N-k} \quad (4)$$

By making now, instead of only one r attempts, each under identical conditions (the same targets in the same arrangement under the same canopies), the effect will be that of dealing with Nr targets in one attempt. Then, the probability that exactly a fraction \bar{c} of the Nr targets, will be seen, $\bar{P} \binom{Nr}{Nr}$ is

$$\bar{P} \binom{Nr}{Nr} = \frac{(Nr)!}{(Nr)!(Nr-Nr)!} \bar{P}^{Nr} \cdot \bar{c}^{Nr-Nr} \quad (5)$$

Equation (5) gives the probability of one event that satisfies our criterion. However, this criterion of at least $\geq Nr$ sightings will also be fulfilled by other events that result in more than $\geq Nr$ sightings. Since the maximum number of possible sightings is Nr , there will be altogether $Nr - \geq Nr$ such events.

Thus, the average probability of experiencing in r attempts a total of at least $\geq Nr$ sightings* of N targets under canopy \bar{c} , $\bar{P}(\geq Nr)$ is

$$\bar{P}(\geq Nr) = \sum_{i=\geq Nr}^{Nr} \frac{(Nr)!}{(i)! (Nr-i)!} \cdot \bar{c}^i \cdot \bar{c}^{Nr-i} \quad (6)$$

First, it should be noted that --

o because it takes into account all the possible

events, $\sum_{k=0}^N \bar{P}(\binom{k}{N})$ equals to unity,

o because it includes all but the single event

of not seeing target at all, $\sum_{k=1}^N \bar{P}(\binom{k}{N})$ is the

probability of seeing at least one target,

o the probability of the event of not seeing

target at all, $\bar{P}(\binom{0}{N}) = \bar{c}^N$,

so that $\sum_{k=0}^N \bar{P}(\binom{k}{N}) = \bar{P}(\binom{0}{N}) + \sum_{k=1}^N \bar{P}(\binom{k}{N}) = 1$, and

*We denote "at least k ," with $\geq k$.

$$\sum_{k=1}^N \bar{P}_{(N)}^k = 1 \cdot \bar{c}^N \quad \text{That is, Equation (2) is the reduced form of Equation (6)}$$

for the case of $\bar{c}Nr = 1$.

Second, the evaluation of Equation (6) for various values of $\bar{c}Nr$ is rather time-consuming.

For this reason--although numerical evaluations of Equation (6) at various \bar{c} , for a range of Nr and \bar{c} , are important and should be computed, the following examples are for only one pair of values of N and \bar{c} .

7.3.2.4 Some Specific Numerical Examples

Equations (5) and (6) have been evaluated for $N = 12$, and $\bar{c} = 0.85$ and are plotted in Figures 7.3.3a and 7.3.3b, respectively. Figure 7.3.3b shows that the average probability of seeing at least one-third of 12 targets in an attempt is 0.09, or, roughly, 10%. While this seems reasonably high, in estimating the tactical value of detection of fires by regular reconnaissance, it is perhaps more important to determine the likelihood of maintaining this level (or any other selected level) of performance.

In Table 7.3.1 are given the probabilities of seeing, in each and every one of ten attempts, at least one-twelfth, one-sixth, one-fourth and one-third, of the twelve targets.

Table 7.3.1 Probability of Maintaining Performance

Least Number of Targets to be Seen Out of 12 Under Canopy of $\bar{c} = .85$	1	2	3	4
Average Probability	0.85	0.53	0.26	0.09
Probability to See Least Number of Targets in All of 10 Attempts	0.21	2.5×10^{-3}	1.4×10^{-6}	5.4×10^{-11}

*These probabilities are not those for seeing preselected averages of 12 targets. These would be given by Eq. (6) which is not computed. A very rough estimate of Eq. (6) indicates the probability of seeing on the average 1/4 and 1/3 of 120 targets would be about 10^{-3} and $10^{-6} - 10^{-8}$ respectively.

SECRET

The calculated low probability of "reproducible" performance in seeing large fractions of this relatively small number of targets at relatively high canopy-density raises a very serious question as to the tactical value of this particular method of scanning for detection, and has implications concerning the type of experimental verification necessary. For this reason, a new and different type of equipment is suggested in (7.3.3).

7.3.3.3 conclusion

The geometrical condition of detection, measured by the probability of seeing, is a strong function of canopy-density: the probability rapidly decreases with increasing density.

This relation between probability and canopy-density strongly suggests definite rules to follow in the design of experiments for the establishment of the degree in which various factors affect the detection of point targets under heavy canopies. The relation also suggests specific scanning methods for use in a tactical equipment.

In case of an experiment it appears unquestionable that more targets should be used, the heavier is the canopy selected for investigation. Furthermore--as suggested early in the study--environmental research, including collection and evaluation of statistical data on a variety of canopies seems necessary prior to extensive experimentation. With statistical canopy-data in hand, a logically sound and reasonably controlled detection-experiment could be designed for a second phase aimed at the verification of predicted results. Then in the experimental detection phase the importance of other factors (perhaps unforeseen) would stand out more clearly. Sound planning of an experiment should at least include analyses to determine the minimum number of targets

SECRET
7.38a

and flights necessary to extract the desired data with given confidence. An attempt should also be made, with similar analyses, to plan the experiment so as to maximize the data obtainable at a given cost level.

It appears that the average information obtainable in a number of attempts (runs) with a scanning technique that takes only one look at each element of the target field is inacceptably low for tactical use against heavy canopies. Acceptable and reliable information regarding the existence of targets under heavy canopy may only be obtained when the canopy is searched for openings over a significant range of look angles. A merit figure for equipment, from the standpoint of compatibility with geometrical conditions, could be based on quantitatively expressed probabilities of "reproducible" performance.

It appears that under geometrically open conditions ($\bar{c} < 0.5$) the line-scanning thermal mapper may be acceptable for tactical application. For \bar{c} up to 0.8 ($0.5 \leq \bar{c} \leq 0.8$) there are very serious doubts as to utility, and for $\bar{c} > 0.8$ it is clear that new instrumentation is needed.

~~SECRET~~

7.3.3 Pertinent Features of a Detection Equipment Tailored to the Geometrical Conditions of Seeing

The probabilities established in the first part of this paper indicate that (on the average) only a very few of a number of targets under canopies of densities $\tau > 0.8$, could be realistically expected to be seen. Since the conditions defined for the derivation of the probabilities are essentially the specifications, in general terms, of a large majority of existing airborne line-scanners it follows that these equipments--no matter how much an advancement in the state of their art they may represent--are not suitable for tactical applications against very dense canopies when probably but a single mission may be flown.

The subject of this part of the present paper is a brief enumeration of the pertinent features of an equipment that could be easily designed and readily built, both in a short time, for successful application to the presently considered tactical situation. In addition to the bare enumeration of these features, some comments regarding the feasibility and complexity of such equipment will also be made. These topics will be discussed under the assumption that Appendix 7.1 has been read. That is, this appendix 7.3 is concerned, primarily, with only the geometrical, not the physical, conditions of detection.

These topics are presented in three paragraphs: the first paragraph outlines a scanner, the second paragraph outlines a recorder, and the third paragraph touches on the aspect of feasibility.

7.3.3.1. A Conceptual Airborne Scanner for the Detection of Point-Targets Under Heavy Canopies

As it has been pointed out in Appendix 7.2, the deficiency in the present application of conventional line-scanners is that they attempt

~~SECRET~~

~~SECRET~~

only once--in an entire mission--to see a target. (i.e., the scanners view an elementary target-area only at a single angle of looking (= scan-angle) within the total scan-field.* In contrast, a scanner designed with the geometrical conditions of seeing specifically in mind, would investigate a canopy (= target-field) for openings at a significant fraction of all look-angles within the angle of hiding. Such a scanner could be built for instance, with:

- o A linear array of detectors** aligned in the image field perpendicular to the direction of flight and.
- o A scanning mode that would cause a part of the target-field, outlined by the lateral total field of view and the scan-angle (see Fig.7.3.4) to be swept during the "line-time" by the projection of the detector array.***

Consequently, the canopy above a target would be completely searched in a strip of width = projected width of a detector-element, and length = distance subtended by scan angle.**** This mode of operation

* A high-quality line-scanner operated at a low V/H ratio has many overlapping scan-lines resulting -- by virtue of a reduced bandwidth due to integration on the recording film--in an increased effective sensitivity. However, no increase in the probability of seeing can result, conversely, from a repeated scan of the same strip ("line") of the canopy if the scanning is made at identical scan-angles. And, except for occasional cases, the re-scannings should be expected to happen, essentially, at identical look-angles.

** Or, perhaps now, certainly in the very near future an image tube of suitable spectral response.

*** For this case, the "line-time" should be expressed as the time required for the airplane to travel the distance which is subtended on the ground by the i.f.v.'s component parallel to the velocity vector.

**** Note that each point in the center-lines of these strips is seen from a target at different elevation and azimuth angles.

~~SECRET~~

~~SECRET~~

would lead to certainty of seeing, under conditions 2(b) and 2(c) in the first part of this paper. Even if this condition is not always fulfilled, the total probability of seeing in a single mission could be expected to be near unity.

The required number of detector-elements could be held at a practical level by some sacrifice in (as is evident from the analysis of the physical conditions of detection in Appendix 7.1).

- o Information-gathering-capacity of the scanner (i.e., sacrifice in lateral field of view which would lead to lesser area searched per unit time), and/or
- o Some sacrifice in sensitivity (i.e., sacrifice in lateral resolution by making the lateral i.f.v. larger than the state-of-the-art is capable of; then, such a sacrifice would probably lead to a smaller ratio of target-signal to background-signal, the latter being the limited noise.)

But sacrifice in sensitivity is readily allowed for targets whose radiative characteristics are equivalent to those of $\sim 1000^{\circ}\text{K}$ black body 6 inches in diameter. Consequently, no matter how much an actual canopy deviated from the definition in this paper,

A scanner as outline above would assure a probability of seeing higher by at least an order of magnitude than a line-scanner's capability. It is reasonable to expect that this very high probability could be attained at an effective sensitivity practically identical to that of the best contemporary line-scanners.

~~SECRET~~

7.3.3.2 A Conceptual Analog Recorder Compatible with Scanners of the Outline in 7.3.3.1

because of the specific scanning-mode, the information from the scanner forms a four-dimensional matrix, as follows:

- o ground distance flown, D .
- o Irradiance in $I(\theta)$, I (= function of scan-angle).
- o lateral field of view, λ .
- o Scan-angle, Σ .

However, since the information sought is the determination of a target's existence and its ground coordinates D, λ , the information from the scanner might be handled by a basically conventional strip-map recorder when the number of targets is not too high. This is so if the detector signal is restricted before recording to levels higher than a threshold set as a suitable multiple of the signal level from the background (canopy and/or ground).

In this case, the lateral position of a target would be correctly recorded. However,--irrespective of the scan-angle at which the detection has been accomplished--the ground-distance coordinate D , of the target would always be recorded at the position of the prevailing point of detection (= point of looking or, at a constant offset from same). Thus, the only added capability required of a conventional device, would be that it also record* the scan-angles.

Existing recorders are usually provided with data channels like that mentioned above.** An increase in data-channel capacity, probably

* In digital form, perhaps.

** At the edges of a strip-map.

needed when the number of targets is high should be a routine matter; and, in view of the expectation that a relatively low resolution would suffice (i.e., the number of elements in the map would be relatively low, taking up but a fraction of the film's width) the increase ought to be readily accomplished.

One can visualize cases when two or even more targets are recorded at the same spot. Nevertheless, no ambiguity could arise when a distinction between the targets' locations is of no interest at which targets exist.

Correlation between the location of the targets and the environment could be accomplished in at least two ways: either

- o the threshold level could be lowered for a duration = dwell-time, preferably at a time when the scan-angle is zero, or, in a brute-force-method.
- o an additional conventional strip-mapper could be used in synchronism with the target-equipment.

In the first solution, a single record would contain both the targets and the terrain; the second solution would result in two separate maps that could be superimposed for evaluation, if both were made at the same scale-factor.*

From the previous outline, it directly follows that the above-threshold signals could be summed before feeding them to the recorder's input. However, the scan-angle information should be derived prior to summation.

* For final evaluation, the IR maps should be correlated with topographic maps in a conventional method.

Consequently, a reflector compatible to the scanner should be a task task to design and manufacture.

3.3.3. Some Aspects of Feasibility of the Conceptual Detection-Equipment

Although the preceding paragraphs have already touched on aspects of feasibility (and this paragraph does not intend to significantly extend the considerations there) still a separate paragraph has been assigned to this area for the mere emphasis of the expectation that no factor would prevent feasibility or would even require any effort worthy to mention of development before an equipment of the present concept could be built.

Thus, the facilitate application of a relatively simple (object-plane) scanning mechanism.

- o The primary optics probably ought to have a field-of-view as wide as the total scan-field. However, in view of the expected low resolution requirement, no difficulties in design and/or fabrication of the optical system should exist. This is especially so because the spectral response would probably be in a region (see later on) where refractive elements could be readily used.
- o It appears highly probable that the optimum spectral region of detection would be in the uncooled PbS region. Consequently, the required linear array of detector--even on a curved substratum-- should be of a so-called routine matter of manufacture *

*Once the uncooled PbS region turned out to be indeed the optimum region of detection, the remaining requirement of the detector is a sufficiently fast response-time. The upper limit of the allowed response time is the

$$\text{Decline-time} = \frac{h \times (1/f \nu)}{V \times b}$$

SECRET

Even if it were desirable to choose the InSb region for detection, an InSb detector array and its cooling should also be well within the capability of skilled and careful fabrication practices in the related fields.

- c. The manufacture of the detector-array should be a relatively easy task, because--being the variance of radiation from the canopy, the limiting noise-- the requirement of uniform sensitivity usually difficult to obtain in a multi-element-detector, would be considerably relaxed.
- c. The large limiting noise would also permit the use of (mechanical) image-plane-scanning, without consequent degradation, for this method's scanning-noise ("optical"-noise) is hardly possible to keep below levels of less than two- or three-times the detector-noise.
- c. Assuming that a lateral resolution of 6 mrad would suffice, some 150 elements could assure a total of about 50° scan-field. Thus, an equal number (150) preamplifiers would be required. In view of the highly developed state of the electronic art, such a preamplifier-package should be very reliable and practical in size and weight. (Transistor amplifiers and visualized.)

where V = velocity, H = altitude of aircraft, θ = total scan-angle. Thus, by calculating the dwell-time for practical values of the parameters, it can be seen that an uncooled PbS array would permit a reasonably high V/H ratio; that is, a large area could be searched in unit time, even with the relatively slow PbS.

SECRET

~~SECRET~~

- o even this slight complexity due to the preamplifier package* could be avoided by using image tubes. The possibility of this solution is quite hopeful in the case of the PbS-region, if a detector sensitivity, relatively considerably less than the best presently possible, would suffice.** A suitable imager-tube, however, is expected to require more lead-time for delivery than is needed in the case of an array-detector.
- o Mechanization of the switching of the individual detector-signals at the output-level of the preamplifiers and at the required rate, should only call for "shelf-components" in case of mechanical switching, and, for well developed circuits in case of electronic switching. Finally,
- o The required data-processing should be an almost trivial matter for this art of great capability.

7.3.3.4. Conclusion

From the point of view of use in tactical application, the over-all merit of an equipment of the present interest--might be termed the probable success--could be quantitatively expressed as the product of the three partial figures of merit of

- (1) Probability of seeing
 - (2) Sensitivity-ratio of target signal to limiting noise,
- and,

* Bulkiness that arises because of the use of finally a brute force method. For, a detector array is essentially an assembly of individually produced elements requiring separate amplifiers.

** On the basis of a first estimate it appears that the present sensitivity of imager-tubes is just below the minimum sensitivity that seems necessary for the contemplated application. Nonetheless, a re-examination of this very preliminary assessment is warranted.

~~SECRET~~

~~SECRET~~
~~SECRET~~

(.) Rate of information gathering-capacity: area searched
in unit time

There is very little doubt that a special equipment designed for tactical size detection would far exceed performance of any existing device

A special scanner for the airborne detection of point targets under heavy canopies could be designed and built from existing elements of conventional IR strip-mappers. Considering the relatively extensive experience in this specialized field, the merging of the elements should be accomplished in an almost routine manner. A similar, if even not easier, situation should exist in making standard strip-recorders compatible with the scanner.

Building and laboratory testing of such an equipment should require no more than 6 to 9 months. The equipment should have about the same size and weight as those of similar existing IR devices and should be readily installed and operated in any airplane suitable for IR mappers. Logistics would be less of a problem than that for existing mappers that operate in the 8-13 micron atmospheric window. About the same effort in maintenance would be needed as for standard IR /electronic devices of comparable complexity.

In view of the fact that the recommended scanner would search the target-field also in regions some 25° - 30° in front of the airplane, it appears quite realistic to expect that the equipment could facilitate--under certain conditions, at least-- a "hunt and kill" operation.

The specifications of the whole equipment could be derived by an about one man-week of effort. If this effort is expended with the results of applicable past experiments on hand, the specification should reflect standard manufacturing procedures and a great probability of successful operation.

7.3.4. Summary

An analysis has been made of the geometrical conditions of detection, measured by the probability of seeing a point target under canopy. The results of the analysis have been evaluated for the

- o Planning of relevant experiments as well as for the
- o Establishment of the concept of a special equipment very promising for tactical use. Furthermore,
- o The feasibility of the conceptual equipment strongly recommended for consideration without delay, has been investigated and,
- o Related questions such as production-time, logistics, etc., have been touched upon.

a) The results of the analysis indicate that an experiment to determine the effect of a canopy and the possibility of detection, should be designed on the basis of canopy density: the higher the density, the larger a number of targets should be used in order to assure measurements of statistical value which is demanded by the very nature of the problem. It has been seen that it is possible to, a priori, optimize the quantity of information collected per cost of an experiment.

SECRET

5) The analysis also indicates that the information regarding the existence of targets under heavy canopies, obtainable by probing for an opening in the canopy at a single angle, is so uncertain that very little tactical value can be assigned to it. Information of such questionable value can be expected on the long run from the use of existing line-scanners.

Motivated by the above finding, the essential features of a specific equipment, which promises of great tactical value, have been outlined. Most characteristically, the recommended equipment would search for openings over a significant range of angles, in contrast to the random single angle at which existing devices hope to find an opening. The recommended mode of search would then assure tactically useful high probability of seeing. Most significantly, the recommended equipment would have an at least by an order of magnitude higher "probable success" than can realistically be expected from existing devices; furthermore, an evaluation of the feasibility of a HUNT AND KILL OPERATION AIDED BY THE RECOMMENDED EQUIPMENT APPEARS WARRANTED.

It appears highly probable that an equipment as outlined could be easily designed and readily fabricated, both in a short time, for all elements of this equipment have long been used by IR line-scanning devices. Moreover, ancillary problems of installation, operation, logistics, should be no more than normal and the equipment might be made simple enough for regular use by indigenous forces.

-7.69-

SECRET

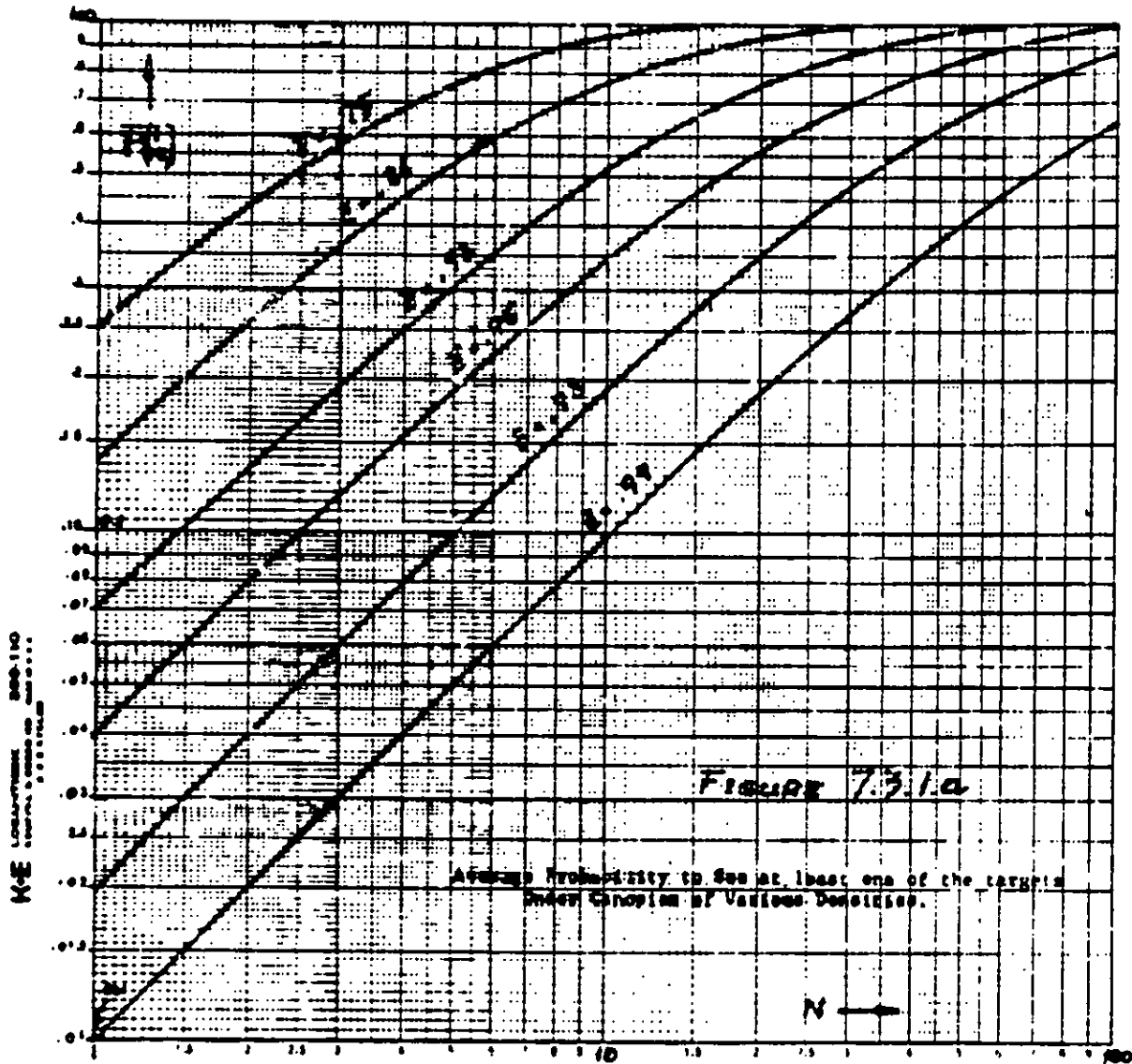

SECRET

NE COMBAT OPERATIONS 300-01
RESEARCH REPORT
2 JUL 68

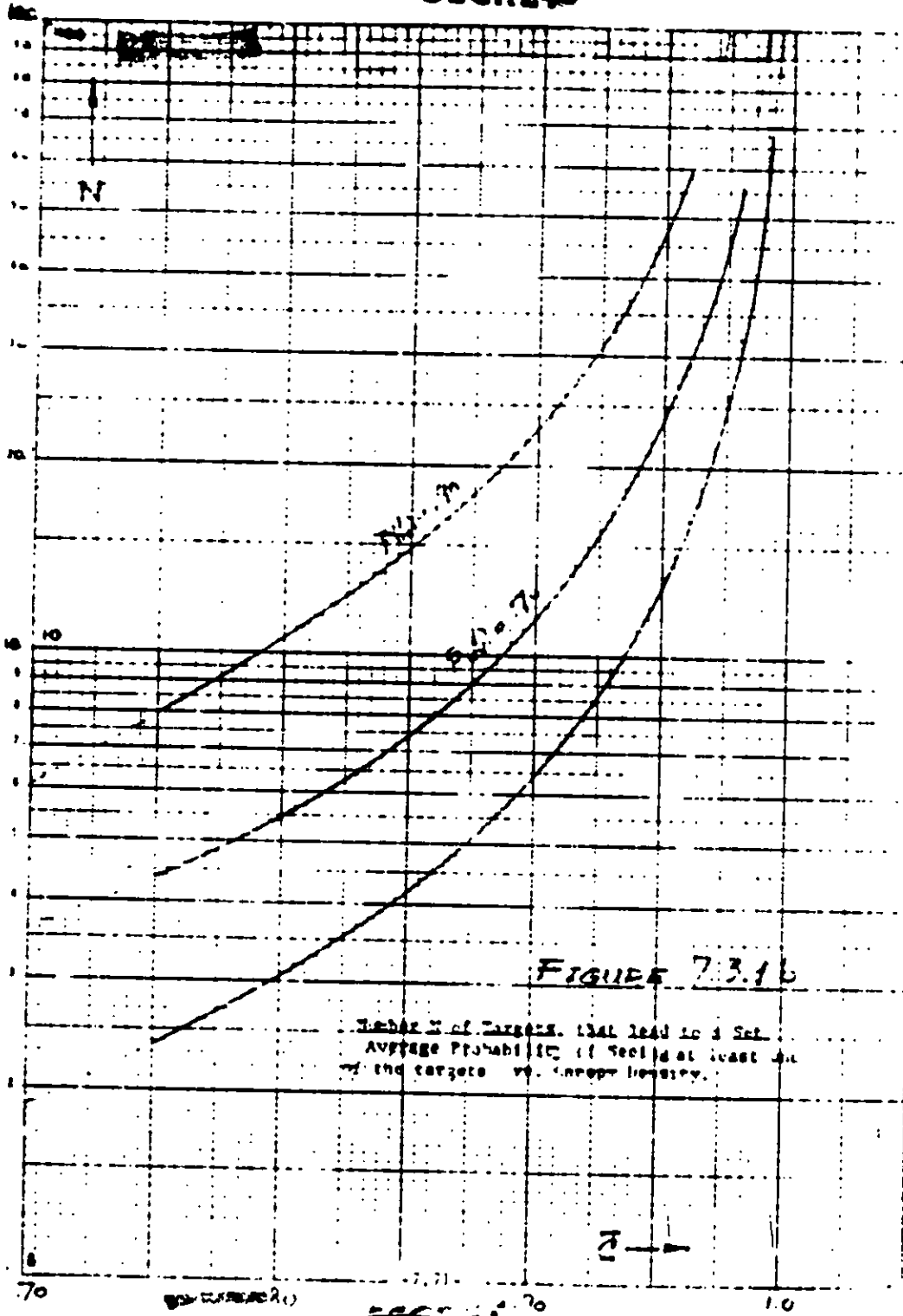

FIGURE 7.3.1b

Number of Targets that lead to a Set
Average Probability of Success at least 50%
of the targets vs. Interceptability.

2 →

70 0.7 1.0

SECRET

GSA

FIGURE 1-3-a

Average Probability of Seeing in an Account, $\lambda = 4$, $\mu = 12$, $\rho = 0.33$

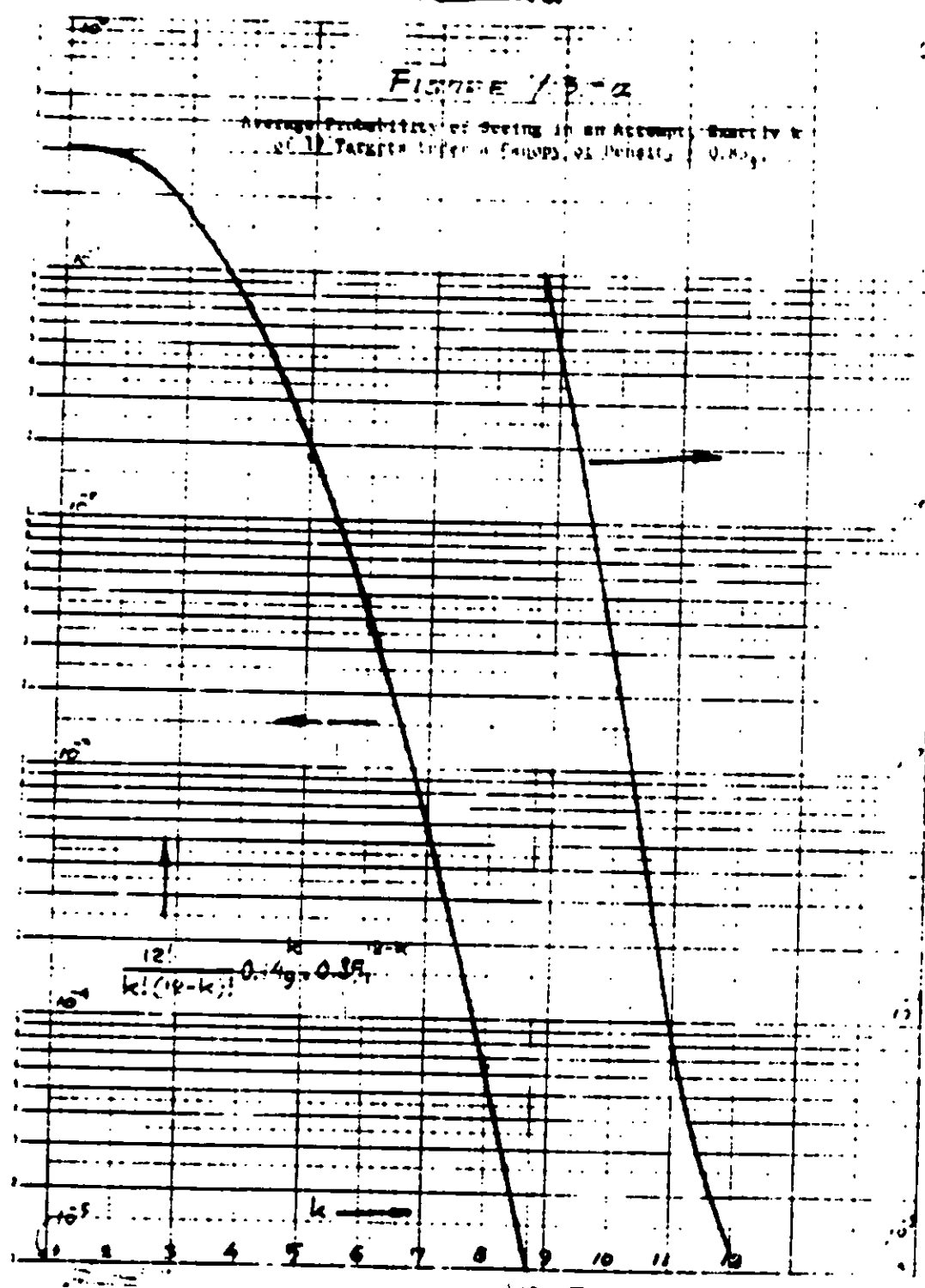

165 100 50

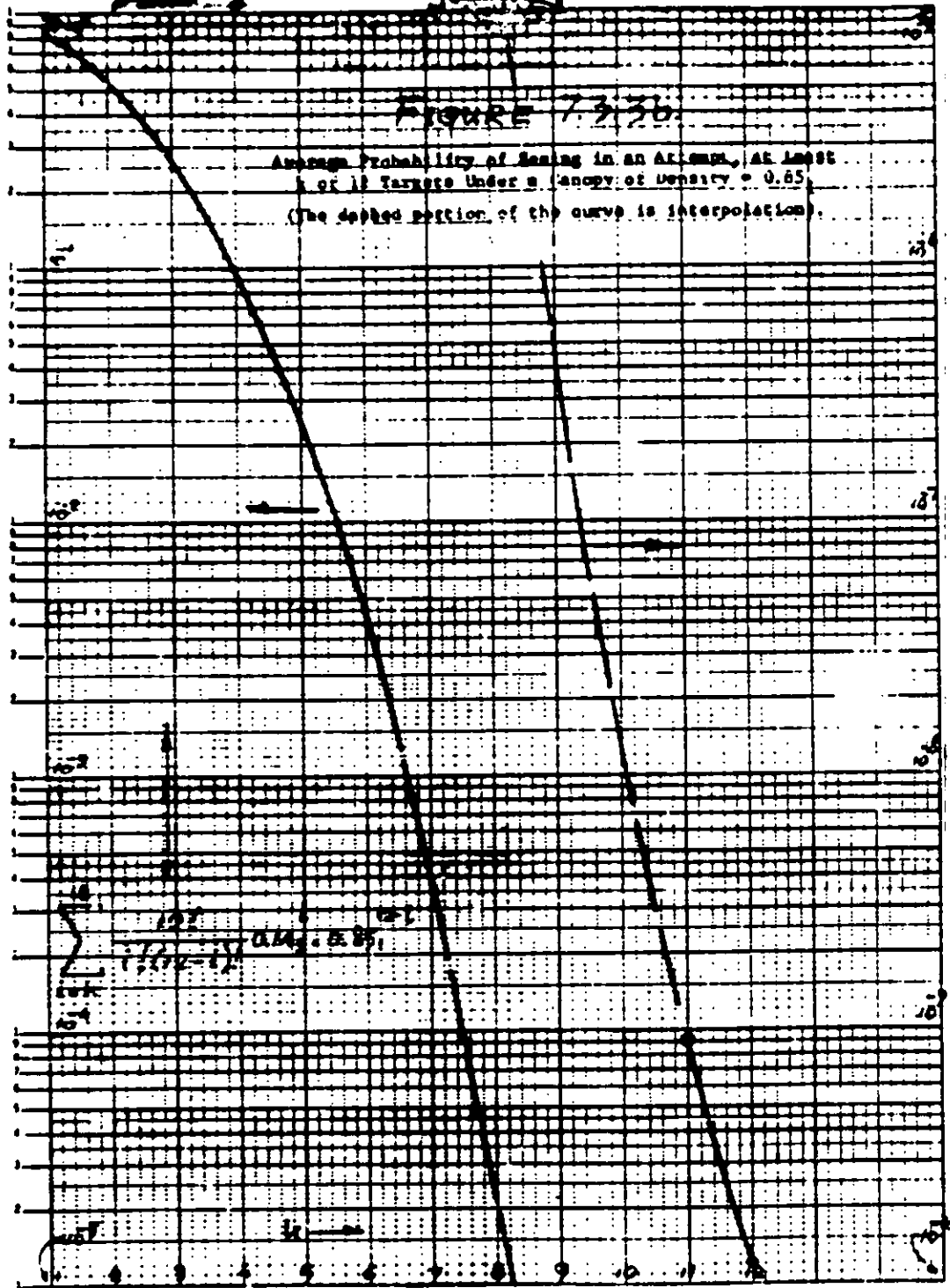

N-2
 385-81
 385-81
 385-81

NOTES:

- ① Area on Ground Viewed by Detector Array During a Dwell-Time.
- ② Scan-Angle: The Area Viewed by Detectors Sweeps through this Angle During a Scan-Time.
- ③ Line of Sight from Scanner to Target, at the Instant that the Target Just could be Detected.
- ④ Line of Sight at the Just Instant Target could be Seen.
- ⑤ Angle of Hiding: The Portion of Canopy Subtended by this Angle, is Searched for Openings. This Angle Equals the Angle in Note (2).

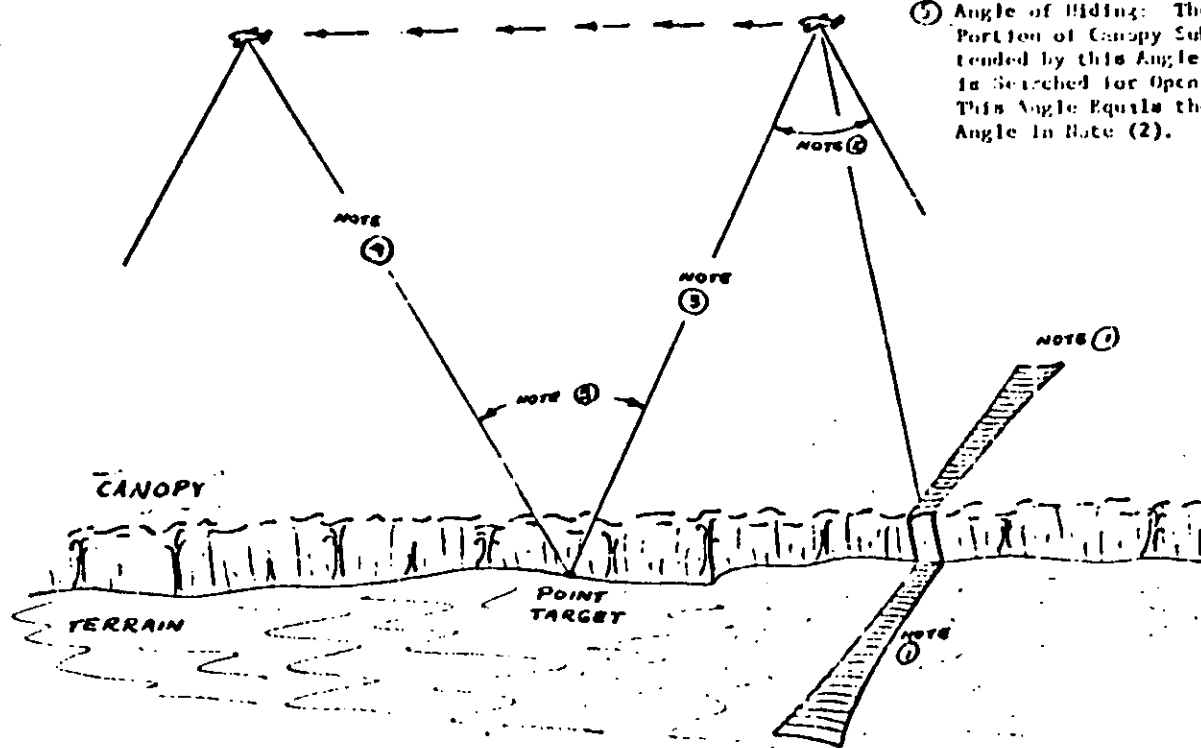

Figure 7.4. A Method of Scanning, for Openings, A Significant Portion of Canopy, to Find Unobstructed Lines of Sight to Point Target.

~~SECRET~~
SECRET

7.4 WAKE DETECTION

CONTENTS

- 7.4.1 General
 - 7.4.1.1 Introduction
 - 7.4.1.2 Rice Paddy Calculations
 - 7.4.1.3 Experience and Applicable Equipment
- 7.4.2 Basic Data Experiments
 - 7.4.2.1 Parameters of Interest
 - 7.4.2.2 Experimental Set-Ups
 - 7.4.2.3 Program Plan
- 7.4.3 "Quick-Fix" Experiments
 - 7.4.3.1 Introduction
 - 7.4.3.2 Equipment for Experiment
 - 7.4.3.3 Experiment
 - 7.4.3.4 Critique
- 7.4.4 Summary

7.4.1 General

7.4.1.1 Introduction

One idea for detection of guerilla operations is based on the notion that aerial IR-surveillance of flooded lands might provide, if the traces of men or groups of men could be observed, patterns of activity from which actionable deductions could be drawn. If the observable effects were immediate and long lasting, trails might be pinpointed. If of short duration only, indications of direction of flight, and possibly of the cessation of flight, might be obtained. It was felt that IR surveillance gear in existence might come close to providing observational capability, although probably not suitable for VN field operation. It has been suggested,

-7.75-

~~SECRET~~
SECRET

~~SECRET~~

and preliminary calculations indicate, that disturbance (e.g., by passage of personnel) of stagnant or slow-moving bodies of water may result in observable changes in the surface layers. The changes may be in the surface temperature, due to mixing, or in emissivity, or both. Lofted, microscopic organic material, plant oils, or fine soils may be introduced into surface layers and be a factor. The situation bears some resemblance to the wakes generated by ships under appropriate conditions. The extent, persistence, and observability of such surface changes are generally unknown although many long-persistent ship wakes have been mapped. There are a few basic measurements in existence. Ewing and McAllister (Ref. 7.5) have measured the long wave IR radiation from the top 0.1 mm of evaporating ocean and demonstrated the existence of a cool surface layer with departures as much as 0.6°C from surface temperature found by conventional methods. Csanady, et al (Ref. 7.6) measured the temperature of stable diffusion-slicks (typically 1-2 meters wide). There were temperature differences of 0.5°C-2.0°C from one side of a slick to the other. On one occasion, with strong solar heating, the center temperature of the slick was 1.0°C higher than that on the warmer side. The slicks were most pronounced and stable at wind speeds around 5 MPH. In general (Ref. 7.7) no basic measurements under controlled conditions have been made. With the basic data missing the potential feasibility of observations in field operations cannot be established. Many situations can be postulated which might arise where the capability to detect such changes would be advantageous in counter-insurgency operations. The Contractor therefore proposed that two types of experiments be made on detectability of such disturbances. These were described as "quick-fix" and "basic data" experiments in earlier reports.

7.5 Ewing, G. and McAllister, E.D., "On the Thermal Boundary Layer of the Ocean, Science, 131, 1374

7.6 Csanady, G.T. et al, "Slicks on Lake Huron," Nature 196, 1305

7.7 Private communication, R. Werner, Institute of Naval Studies

~~SECRET~~

SECRET

The basis of the "quick-fix" experiment was that certain airborne surveillance equipment was available which could be used, at very low cost, to obtain pictures of a simply disturbed stagnant body of water. It was felt that, although such an experiment could not be conclusive there was some small chance that early pictures would be informative and might conceivably point the way to useful application of existing devices. One such "quick-fix" experiment was done under unsatisfactory conditions. The "basic data" experiment is an essential supplement to determine the quantitative characteristics of the phenomena and the design parameters and operating technique required in surveillance instruments to detect them.

Unfortunately, some people have concluded, we believe prematurely, that such detection will not be operationally useful. For example, the opinion has been advanced that the normal mode of transit of rice paddy land is by walking on the dikes, and also that since farmers disturb the paddy waters in their normal work, the technique would be useless.

The Contractor feels that this conclusion is incorrect on at least three counts: (1) a variety of normal or contrived situations can be imagined when detection of such disturbances would be useful; (2) the detectability and persistence of changes arising from disturbances is simply not known; and (3) such pictures of actions as are available (an existence proof) (Ref. 6.24 and Ref. 7.5) happen to show guerillas fleeing across flooded lands.* On the first count one can visualize the possibility that

- o night-time dike-walking is contrived to be unsafe-- forcing guerillas to walk through paddies;
- o there are extensive swamplands which must be traversed by guerillas;

* Life, January 18, 1963

SECRET

- o guerillas travel in canal waters and slow-moving streams, because travel is easier, or in order to avoid scent tracking, or for other reasons;
- o in the Khorat, where there are many shallow pools, guerillas may take the shortest route, or seek to avoid dust clouds (Ref. b.18);
- o guerillas are forced to flee across flooded lands toward their preassigned rendezvous points, etc.

On the second count--it is simply not known how long disturbances persist, or what is required to observe them.

- o It may be that farmers netting crabs and working in the paddies during the day produce surface disturbances which persist throughout the night-time hours and would tend to overwhelm any subsequent disturbances. On the other hand, the observable effects may last only a short time (10 minutes to 2 hours) and hence the "memory" of the water is short.
- o Existing infrared surveillance gear may produce all the data desired, or it may not. The likelihood is high that much better data-processing, at least, could be employed.

These, and many other questions cannot really be resolved without quantitative, experimental data.

In surveillance work one of the great difficulties encountered is lack of patterns. This technique, if successful, might be particularly useful in relieving this difficulty.

SECRET
-7.78-

~~SECRET~~

In summary, the contractor believes that the potentialities of this somewhat unusual surveillance method should be established by first following the normal scientific procedures of analysis and experiment, and only then coupling results into operational research.

7.4.1.2 Rice Paddy Temperature Calculations

While, admittedly, temperature may not be the dominant factor in controlling the observability of surface variations on disturbed stagnant pools. (i.e., organic particle suspensions and oils, and fine inorganic matter may be as important), an attempt was made early in the study to estimate temperature variations as a crude measure of equipment requirements. These calculations, although the conditions assumed there (or, the omission of possibly important effects) might make the case virtual, are given below:

a. The Steady State Rice Paddy

Calculations can readily be made for the "still-water" case - i.e. with the assumption of negligible wave action or convection.

The one-dimensional time dependent diffusion equations are

$$\left. \begin{aligned} \rho c \frac{\partial \theta}{\partial t} - \frac{\partial F}{\partial x} &= 0 \\ F - K \frac{\partial \theta}{\partial x} &= 0 \end{aligned} \right\} (1)$$

where
 θ is temperature
 F is heat flow
 K is medium's thermal conductivity, and
 ρ = density
 c = specific heat
 α = K/pc

~~SECRET~~

Solutions to (1) have the form

$$\left. \begin{aligned} F(t, X) &= \sum A_1 e^{j\lambda_1 t + \lambda_1 X} \\ \text{and } \theta(t, X) &= \sum \frac{A_1}{\lambda_1 K} e^{j\lambda_1 t + \lambda_1 X} \end{aligned} \right\} (2)$$

$$\text{where } \lambda_1 = \sqrt{\frac{j\omega}{m}}$$

If the system is driven by a time-varying heat flow essentially independent of temperature, (2) can be Fourier transformed to

$$\left. \begin{aligned} F(\lambda, X) &= A(\lambda) e^{X \sqrt{j\lambda_1/m}} \\ \theta(\lambda, X) &= \frac{A(\lambda) e^{X \sqrt{j\lambda_1/m}}}{\sqrt{jK\lambda_1 c}} \end{aligned} \right\} (3)^*$$

If the diurnal heat flow is assumed sinusoidal (i.e., $\omega = 7.3 \times 10^{-5}$) of maximum amplitude F_0 at $X = 0$

$$\text{then } \theta_{\pm} = \frac{F_0}{(1 + j) \sqrt{K\lambda_1 c/2}} \exp(X \sqrt{j 7.3 \times 10^{-5}/m}) \quad (4)$$

where θ_{\pm} is the maximum temperature excursion during the diurnal variation.

For water (cgs units) $c = 1$, $\rho = 1$ and $K \approx 10^{-3}$. Thus

$$\theta_{\pm} = \frac{F_0}{(1 + j) 1.9 \times 10^{-6}} e^{(1 + j) (.19)X} \quad (4a)$$

*The coordinate system used has the water surface at $X = 0$ and negative values of X below the water surface - Hence Equation (3) and following, hold only for $X \leq 0$.

The spectral functions of Equation (3) apply, in which case $F(u,0)$ can be considered to represent a unit step of amplitude F_0 , occurring at the time the orders stirred up the water, then

$$F(u,0) = \frac{F_0}{j\omega} = A(\omega) \quad (6)$$

and the temperature spectral function becomes

$$\theta(\omega, X) = \frac{F_0}{\sqrt{\pi K \rho c}} \frac{X \cdot \sqrt{j\omega/m}}{\omega^{3/2}} \quad (7)$$

The corresponding time function at $X = 0$ is

$$\theta(t,0) = \frac{2F_0}{\sqrt{\pi K \rho c}} t^{1/2} \quad (8)$$

or, using the constants used with Equation (5),

$$\theta(t,0) = .3 t^{1/2} \text{ degrees centigrade}$$

Thus after one hour a temperature recovery of 20°C can be expected (assuming no surface mixing).

The Fourier transform of (7) for $X \neq 0$ yields

$$\theta(t,X) = \frac{2F_0}{\sqrt{\pi K \rho c}} \left[t^{1/2} \exp\left(-\frac{X^2}{4\alpha t}\right) - \left(\frac{X^2}{\alpha}\right) \operatorname{erfc}\left(\frac{X^2}{4\alpha t}\right)^{1/2} \right] \quad (9)$$

For interesting values of X and t the probability integral term is swamped by the exponential, and, approximately,

$$\theta(t,X) \approx \frac{2F_0 t^{1/2}}{\sqrt{\pi K \rho c}} \exp\left(-\frac{X^2}{4\alpha t}\right)$$

the value of F_0 is of the order of $.01 \text{ cal/cm}^2$ during the day, and about the same on a clear night if ϵ is taken to be 1. This yields

$$\theta_s = 37.0 e^{-.19x} \quad (5)$$

Hence the surface temperature, as a function of the mixing depth, δ , is

$$\theta_s = \frac{37}{.19} (1 - e^{-.19\delta}) \quad (5a)$$

Surface temperature maximum diurnal excursions for some reasonable mixing depths are:

Mixing Depth (cm)	0	5	10	50	100
Maximum Temperature Excursion ($^{\circ}\text{C}$)	37	24	16	3.9	2

Thus one would expect a diurnal variation of 2° in a 1 meter deep paddy even if complete mixing occurred.

The phase of the thermal peaks at the surface is seen to lag the peaks of flux by the reasonable value of $1/4$ day. Thus maximum and minimum water temperature at the surface occurs at 8 P.M. and A.M. respectively. The effects of local mixing near the surface are probably so strong as to make lag calculations as a function of depth by means of Equation (4a) meaningless.

b. The Transient Rice Paddy

From the foregoing it can be seen that the surface water layer (10 cm or so thick) of a rice paddy can normally be expected to differ in temperature by perhaps 10°C from the lower layers. If this condition is changed as a result of men wading through the paddy, what is the time history and temperature change thereafter:

~~SECRET~~

The argument of the exponential for a depth of 1 cm reaches unity at a time of 250 seconds, and for 4 cm at about one hour. This would indicate that if surface mixing down to something below 4 cm occurred, the one hour surface temperature recovery of 20° (calculated in (9) on the assumption of no mixing) might be expected to be less by perhaps 1/2.

In summary, based on elementary diffusivity theory modified to provide for surface mixing, it can be expected that rice paddy surface temperatures on a clear night would average some 10°C cooler than the bottom. Further, if mixing occurs, it can be expected that the disturbed region initially assumes the bottom temperature, cools about 5°C the first hour and thereafter about as $t^{-1/2}$.

Lateral mixing should not be significant beyond a few cm, in the absence of currents, hence spatial extent of the disturbed thermal region should be comparable to the region of physical disturbances caused by wading men.

7.4.1.3 Experience and Applicable Equipment

In the first months of the study a survey was made of existing commercial and military radiometers, scanning radiometers, and thermal mappers, to locate equipment which might be useful for "quick-fix," basic, or terrain mapping experiments. Since much of this material is still pertinent and timely, it is repeated here.

A. INFRARED MAPPERS AND PROGRAMS

I. Navy

The Navy has a program to examine ship wakes by thermal mapper. Supporting work is being done by NRL in Chesapeake Bay (Contact: John Sanderson, Superintendent, Optics Division, NRL), at the Naval Air Development Center,

~~SECRET~~
-7.82-

Johnsville, Pa. (Contacts: Mrs. Paul Moser and Lee, scientists in charge, or Captain Krane, Commandant); and at the Scripps Institution (Contact: Dr. MacAllister, Chief, Applied Oceanography Group, San Diego). A visit was made to the latter on 27 June (clearances go to the University of California, Marine Physics Laboratory, San Diego 52, California).

a) Scripps

Dr. MacAllister showed a number of thermal map pictures, taken over the ocean. These showed surface ships, ship wakes, and a number of oceanic features such as temperature fronts at estuaries and the effects of turbulence over mounts. In addition, some maps of inland Key West were available, showing a small inland body of water. The ocean pictures were made with a rented Haller, Raymond & Brown instrument (AN/UAS-4) mounted in a D-18 (this instrument being a predecessor to the AN/UAS-5 by Texas Instruments which made the Key West pictures).

The ship wakes photographed were visible for distances as great as about 30 ship lengths. There were a considerable number of electronic artifacts in the pictures but most were easily identifiable. For example, a ship stack would be very white followed by a long dark overshoot along the scan, and a short white overshoot followed the cool ship outline. Since the sweep was 180°, distortion at the edge of the map was very bad. No ocean temperatures were available to check these maps but from other experience Dr. MacAllister judged that the wake was seen primarily because of a change in emissivity caused by mixing of lower level (dead) organic matter with surface waters.

In one of the tests the aircraft had been sent over a known mount fairly near the surface. This mount was identifiable as a map variation.

~~SECRET~~

The New West pictures were displayed in a Texas Instrument report (Ref. 7.8) of a test project by Air Development Squadron 1, U.S. Naval Air Station, Key West, Fla. Conditions were:

12-6-61 at 2100 hours weather clear

2500 ft altitude

Speed - 150 knots

180° field of view

Hg-doped Ge cell

Temperature resolution 0.05°C (1)

Angular resolution 2 milliradians

The pictures were extremely detailed and impressive and while there were no identifiable events similar to those of interest to us, one felt encouraged as to possibilities.

Dr. MacAllister had rented an aircraft and mapper from HRB (see III below for source data) but had ordered an AN/UAS-5 from Texas Instruments in preference to HRB equipment. His primary reason was that HRB did not provide a last-mile memory device or nearly real-time viewer such as is available with the I.I. device. He felt that any operational Navy gear would have a requirement for real time viewing and could not afford the 15-20 second delay which is about the best that can be achieved with an Anaco Rapid Processor which may be used with HRB device*.

Dr. MacAllister was interested in AGILE problems. He volunteered that he might be willing to enter into a reasonable experiment with it if

* It is interesting to note that the Fort Monmouth project people have essentially abandoned the real time viewers as a source of continual trouble in use of the UAS-5.

7.8 Keener, P., Preliminary Data for IR Detection Test, December 18, 1961
Texas Instruments (6000 Lemmon Avenue, Dallas, Texas)

~~SECRET~~

~~SECRET~~

~~SECRET~~

this seemed desirable.

During a subsequent visit to Scripps for other purposes, the opportunity arose to view some rather striking maps made of still sea-surfaces with the UAS-5 recently delivered to Dr. MacAllister. These show a widespread and distinct cell-like structure to the water surface bearing a crude resemblance to pictures of Benard patterns.

- b. Naval Air Development Center, Johnsville, Pa., ASW Laboratory, Special Methods Division, Applied Physics Section (ASWL Code 411), Mr. J. J. Pello, July 18, 1962.

NADC started its extensive work on the thermal mapping of ocean surfaces with an airborne ~~Scanning~~ radiometer. This instrument resulted in data on the temperature of a single "line" below the aircraft. Later on, the following scanning equipments were used:

AN/AAS-4 (X-A-2)
AN/AAR-9 (X-A-2)
Reconofax Camera
IR ASW Bomb Director light Unit
AN/AAR-13 (X-H-1)
AN/AAD-2
AN/AAD-2 Modified by NADC

With the AN/AAD-2, NADC used a copper-doped Germanium detector and obtained very good pictures with an estimated temperature sensitivity of $1/4^{\circ}\text{K}$. The pictures have been made with dc restoration and so the "temperature" of far-apart areas has been mapped in correct relation. That is, the average level of these areas, as well as the temperature-variation in the areas has been properly recorded. In maps made of the ocean proper, the surface temperature of deep water appears cooler than the surface of shallow water. Since NADC's aim is an extremely high temperature sensitivity, they modified the AN/AAD-2 to a 1° square instantaneous field of view and achieved

~~SECRET~~

SECRET

a temperature sensitivity as high as 0.01-0.001°K. It is interesting to note that the boundary between a cool and warm surface is remarkably sharp on a picture made from the Lakeside Lake reservoir showing the reservoir's discharge into the ocean. The maps made with this modified equipment show extremely fine temperature details of the ocean surface, without any trace of equipment noise, in most cases. Significantly, there is no noticeable variation in detected temperature with sample scan.

NADC selected a number of typical maps for publication under the title, "Atlas of Infrared Sea Background Patterns," by P. M. Moser and J. J. Pello. This Confidential report was to be published in about two or three months. Unfortunately, no spare prepared draft is on hand for earlier reference.

Since NADC is concerned with ocean surfaces, and maps of inland waters, small-area variations of these surfaces have not been NADC's concern. Mr. Pello suggested that perhaps the Army Electronic Proving Grounds at Fort Huachuca would have specific information regarding such targets. As far as active NADC participation in a special investigation of these targets is concerned, any request should be directed to the Commanding Officer, NADC, Attention Room 3000-1111, Bureau of Naval Weapons, Code RUDC-43. It is unquestionable that NADC's broad experience in observing radiation from water surfaces and in the airborne detection of wakes represents an invaluable reservoir of specific knowledge.

11. ARMY

- a. Fort Monmouth. On 29 June visit was made to Fort Monmouth, U.S. Army Signal Research and Development Laboratory, Reconnaissance Branch, Surveillance Department, Airborne Equipment Section, to talk with the project engineer (Herman Pardee) on the AN/UAS-5 and with the Branch Chief, Daniel Kelly.

The UAS-5 employed in the Panama tests was back at the laboratory under repair. The pictures taken were not available, being processed by a Mr. Warner Lawrence at Evans Signal Laboratory. It was said that the tests were not conclusive (nor informative) and that, as predicted, the UAS-5 was down about two-thirds of the time. The mapper is about two years old and has logged about 2000 hrs. It is subject to an increasingly frequent series of electromechanical and electronic failures which are difficult to repair because the UAS-5 was built for use in the SD-5 drone and is integrally wired (i.e., there are no plug-in boards or other aids to rapid maintenance).

One of the difficulties encountered in Panama was that paint flaked off in the high-humidity conditions and got in the film drum. (The UAS-5 probably doesn't need paint as it is aluminum.)

The Army has two UAS-5s, the one at Monmouth now, and one which was delivered to Fairchild at Yuma and is not used for observations. Apparently the Yuma instrument could not be used in Panama because of a contractual commitment to Fairchild. USASERDL apparently could not get money for any new UAS-5s. It was stated that new models of the device would be built for easier maintainability. (Estimated \$100,000 for device.)

Some pictures were available (Ref. 7.9) which covered a large variety of conditions. The detail was extraordinarily good in all cases. Maps of airfields showed distinctive differences between cold and hot aircraft and places where aircraft had been parked but where the outline was still preserved as a temperature difference. Maps over forests showed large differences in the apparent temperature of foliage.

There were two particularly interesting pictures. One was of a Boeing 707 warming up and showed the jet exhaust back to about five plane

7.9 Final Engineering Report on Hg-Doped Germanium Detector Evaluation, CI-61147-1, 20 December 1961, Texas Instruments Contract No. (USASC) DA-36-039-5C-88977 (Secret)

~~SECRET~~

lengths against the even background of the turnaround pad. The other showed a reservoir and associated pumping station with warm water from the station flooding the main pool. The pumped water was a few degrees higher. Many fine gradations of temperature could be seen in temperature fronts of water flooding the pool.

0. U.S. Army, Evans Signal Laboratory, Fort Monmouth, J.J., Sgt.
William Kipper, July 20, 1952.

The purpose of this visit was to inspect the thermal maps made in the Panama tests of the AN/EAS-5 between 5 May and 28 May 1952.

The purpose of the tests was to evaluate the equipment for use in tropical regions. The tests have been made over a designated area. This area is approximately a 6-mi long and 2-mi wide strip about 1-1/2 mi to the West and roughly parallel to the Panama Canal. The 2-mi wide Southern boundary of the area is roughly at the latitude of the Southern shoreline of the city of Panama. The terrain is mountainous (elevations up to 800 ft) and is covered with jungle.

The equipment had numerous breakdowns. Failures occurred primarily in the recording unit (point-particles, recording-lamp) and in the detector-package. However, the photographic cameras (KA-20, KA-220, KA-39) also used in the flights, jammed even more frequently. Consequently, but understandably, the result of the tests is not voluminous.

The maps obtained were made at a flight altitude between about 1000 and 5000 ft.

Unfortunately, the original negatives show, invariably, very low contrast and often have been underdeveloped. Moreover, in a large percentage of the maps, one edge of the map was not exposed at all as though the recording lamp did not ignite. It was impossible to estimate whether the low

~~SECRET~~

attributed to due to maintenance (corrective operation) of the equipment, or due to an inherently low contrast of the target area, or to a generally poor atmospheric transmission because of extremely high humidity, or to fogging of the detector window, or to the combined effects of these conditions. (Had a map been made at the beginning or end of the flight of the city, some clue would now be available to at least partially resolve this question). This situation is especially unfortunate because two very interesting experiments had been planned.

In one experiment, a convoy of 5 and 2-1/2 ton trucks in about 75-ft distance and up to 12 in number, proceeded in a very narrow (truck-wide) road under a canopy of trees. The thermal map shows very clearly a few of these trucks. However, DKO opinion is that these trucks appeared in openings of the canopy, just as photographs, made during the same flight, although not simultaneously, show trucks not under canopy.

The other experiment involved a number of large campfires lit in about 80' high jungle. The fires, about 4' in diameter, were allegedly clearly detected but it was said that the pilot has also seen the fires from the flight altitude of about 1500 ft so that, probably, a direct line of sight existed between a fire and the airplane. (This record was not in the Evans Signal Laboratories at the time of the visit.)

Sgt. Klepper mentioned some interesting meteorological phenomena of the jungle. Early in the morning, heavy mist or fog sets on the jungle until the sun burns up the fog. Moreover, right after rain, the jungle "steams" heavily for about an hour. However, such "steaming" has not been observed on the top of the mountains. (Note that the flight tests have been delayed until the fog dissipated. Some maps show patches of clouds; the maps do have

SECRET

details of the terrain through the edges of the cloud or through very thin strata of clouds.) Sgt. Klepper called to our attention a Quartermaster General report on the meteorological aspects of the jungle; however, the report was not available.

c. University of Michigan Institute of Science and Technology, Infrared Laboratory, Drs. G. H. Suits, C. J. Zissis, Messrs. M. Holter, J. Morgan, W. Wolfe, 24 July 1962.

The Infrared Laboratory is very well equipped with infrared scanners. Installed in R4D aircraft, the laboratory operates a modified AN/AAR-9 and a modified AN/AAD-2 with a 1-mrad instantaneous field of view. The laboratory recently obtained five complete sets of AN/AAS-5 systems; these equipments are currently being modified to a 2-mrad field of view and will be installed in L-20 aircraft. Moreover, the "Project Michigan Wide Angle Scanner" is installed in an L-23 aircraft.

A number of detectors are available for use in these equipments, covering the spectral region from about 1 micron to 13 microns. The long wavelength detectors are either copper or mercury doped germanium. The cooling of these detectors is accomplished by liquid N₂ and He poured in a double dewar. According to Mr. Holter, no difficulty is being encountered in operating the equipment in this fashion.

The AN/AAS-5 is a two-channel equipment with the following characteristics:

AN/AAS-5 (XE-1) (Ref. 7.10)

Designed for mounting in L-20 aircraft

Weight--300 lbs; Power--33 amp 28 VDC

Optics: Two back-to-back identical. Radiation folded by one of two perpendicularly-mounted plane surface rotating scanner collected by 6" f/0.8 parabola, folded again

7.10 Optical-Mechanical Scanning Devices, University of Michigan IRIA State-of-the-Art Report: May 1958.

by flat mirror, and focussed on cell. CLC is 0.25 mm;
 f_{eff} 1.1, angular resolution-4 mrad., focal length-5 in.

Detector: A photoconductive detector 0.5 x 0.5 mm is placed in focal plane; PbS on one side; cooled PbSe or PbTe on the other.

Scan: Only 85° center of each scan is displayed. Forward scanning is due to aircraft motion. Each detector traces 120 lines per second so that successive scan lines just touch at 175 mph, altitude 500 ft.

Design

Objective: PbS--min. detectable signal of 1.8×10^{-12} watts
PbSe--min. detectable signal of 3.4×10^{-11} watts at 2.5u

This leads to a temperature sensitivity of about 1°-2°. Kelly, at USASRDL felt that Hg-doped-Ge cells could be used, that the cell change could be made by a company like TI in about 5 months and get sensitivities of fractions of a degree.

The Laboratory has begun a 1-1/2 year program to collect detailed data on the temperature of terrain, as a function of the time of the year. Data will be taken twice monthly, mapping the same terrain each time around the clock to resolve the effect of the time of the day. In addition to this activity, the Laboratory has an extensive program in mapping snow-covered crevasses in ice-caps.

The Laboratory has made thermal maps showing very fine detail. Maps of runways with simple resolution charts indicate that perhaps better than 1-mrad resolution has been attained. Various vehicles in this map made from an altitude of 500 ft can be distinguished according to the type of the vehicles. It is interesting that a person without a shirt in one of these

maps is positively detected (but not identified) whereas another person with a shirt on is missing from the map. Maps of highways made with the same equipment from 500-ft altitude very clearly show a distortion of vehicles due to their motion (the scan-line was perpendicular to the road).

Such very high resolution maps with very good temperature-sensitivity can only be obtained by considerable attention to the equipment. The resolution is simultaneously limited by a number of factors. These factors may be the instantaneous field of view, the definition of the optical system, the size of the recording spot, the synchronism between scanner and recorder and the stability of the aircraft. Consequently, a further increase in resolution requires simultaneous improvement on all these factors.

In the meantime, correct operation of an equipment is the all important factor in obtaining an optimum map.

Mssrs. Holter and Morgan offered to make a map of a nearby pond with and without disturbance, during the course of a regular mission under one of the Laboratory's contracts. Because of contract requirements the map will bear a Confidential classification.

Considerable work on IR, oriented to combat surveillance problems, has been participated in by the Laboratory. (Ref. 7.11, 7.12, 7.13).

III. Air Force

- a. USAF Aeronautical Systems Division, Wright-Patterson Air Force Base, Ohio, Reconnaissance Laboratory (ASRNR), Infrared Section (ASRNRS-3), Mssrs. C. L. Woodard and K. H. Grimberg, July 16, 1962.

In the opinion of Mssrs. Woodard and Grimberg, there is no "shelf" equipment with a capability comparable to HRB's Reconofax VI (see HRB-Singer below) and to the AN/UAS-5. As far as airborne IR studies are concerned, HRB 7.11 Morgan, Joseph, and Dana C. Perker, An Analysis of IR Combat Surveillance and Target-Acquisition Equipment for Use in Expeditionary Operations of the Marine-Landing Force (U), IR Laboratory, Institute of Science and Technology, U. of Michigan, June 1962 (Secret)

~~SECRET~~

has the most extensive experience. Interpretation of IR reconnaissance data is managed for the Air Force by Home Air Development Center (J. Poherenc, NAWHC, Ext. 21122).

At this time, the IR section was not flying thermal mappers. However, the Reconnaissance Laboratory had on order a UAS 5 modified for 2-channel operation. One channel to operate in the region between about 3 and 5 microns with a liquid N₂ cooled InSb detector; the other in the visible region of the spectrum using a photomultiplier detector. The total scan angle of the equipment to be 146° wit. an instantaneous field of view of 1.5 mrad. The temperature sensitivity of the InSb channel to be about 0.1°K. The equipment will be operated at altitudes up to 55,000 ft. The IR information will be recorded on 5" film. This equipment will serve an experimental study that is aimed at in-flight correlation of visual, infrared and radar data to be obtained in an integrated system.

The Infrared Section of the Reconnaissance Laboratory had just initiated a study of the detection by passive radiation of small bands of troops and camp sites, using multicolor techniques.

Mrs. Woodard and Grimberg, were not aware of past or present theoretical or experimental investigation that would be applicable to the problem of wake detection in small bodies of water. Investigation of the detection of campfires, would be undertaken during the course of the above-mentioned study.

- b. RF-110. Texas Instruments has a subcontract from McDonnell Aircraft to provide 10 AN/UAS-5 equipments for use in the RF-110.

- 7.12 Symposium on (SESS) (Unclassified Title). ONR Symposium Report ACR-54, Office of Naval Research, Department of the Navy.
- 7.13 Proceedings of the First Symposium on Remote Sensing of Environment, 13-15 February 1962, IR Laboratory, Inst. of Science and Tech., U. of Michigan, March 1962, NOur 1224(44) (Unclassified)

IV. Malter, Raymond S. Brown-Singer, Inc., State College, Pa., Dr. C. L. Woodbridge, Messrs. J. W. Sobel and J. P. Walker, July 19, 1962.

In a company-sponsored program, cogent design changes in the AN/AAD-2 (Reconofax IV), resulted in a high-speed IR detecting set capable of operating at speeds up to Mach 1.1 at an altitude of 1000 ft. This new system, designated as Reconofax VI is about the same size (approximately 1' x 1' x 1-1/2') and weight (47 pounds) as its predecessor. The equipment has a 3-mrad field-of-view and, at a maximum V/H ratio, temperature sensitivity of about 0.1°K using a liquid N₂-cooled InSb detector. The detector package is designed as plug-in units so that all current and future detector types can be used in the system. The detectors are readily interchangeable during flight. Besides recording in flight, by means of an FM transmitter, the Reconofax VI can telemeter the raw video data to a ground-based recorder.

Under development is Reconofax VI-B with an instantaneous field-of-view of 1-mrad and a second signal channel in the visible region of the spectrum.

Another system, Reconofax VII will be an ASW-type scanner. It will have a 10" aperture diameter in contrast to the 3-1/4" collector of the previous systems and an instantaneous field of view of 1°.

With an InSb detector, a temperature sensitivity of about 0.001°K is expected; with a Ge \div Hg detector but otherwise, under identical conditions, a fivefold increase in temperature sensitivity is expected.

These latter systems will have a continuous calibration recorded on both edges of the ship-map. Consequently, the absolute "temperature" of the areas will also be possible to evaluate in addition to the "temperature difference" that prevails between various areas of the target field.

~~SECRET~~

HRB-Singer is also working on the development of a 2-fluid cascaded refrigeration system for Aeronautical Systems Division, Wright-Patterson AFB, Ohio. The program is aimed at a closed loop cooler that can facilitate detector operation either at 30°K or 80°K; it is about 1/2 to 1 year from completion. It is interesting to note that in Dr. Woodbridge's and Mr. Sobel's opinion, field operation of a 30°K detector, without a closed loop cooler, is impractical, because of the restriction to nearly vertical orientation of the detector-package.

It was noted that assuming that a wake has a temperature differential of 0.1°K, detection is very possible, once the contrast between pond and terrain--which may be as high as tens of degrees--has been eliminated by removing the low-frequency response of the equipment. The pond would probably appear as more or less uniform background so that no dynamic range problem would exist. According to Mr. Walker, experience shows that a line shape in a two-dimensional picture can be detected when the difference between signal and background is perhaps as little as 20 per cent of the equipment noise.

As reported earlier HRB-Singer has an equipment available for rental. The cost of the airplane is \$100/flight-hour, the cost of the equipment is \$170/day and the cost of field engineering services is \$100/day when away from State College. Mr. Walker suggested that the starting point of the disturbance and the point where the person causing the disturbance would leave the pond, should be marked by beacons so that the approximate location of the disturbance could be positively identified on the map. For daytime measurements, a spectral region above 3 or 4 microns has been suggested (Ge + Hg detector); for night-time measurements, the region between 3 and 5 microns would be advantageous because of the availability of various size InSb detectors

~~SECRET~~

~~SECRET~~

~~SECRET~~

could facilitate a coarse determination of the size of the disturbance.

B. EQUIPMENT FOR FIXED-SITE EXPERIMENTS

I. Baid-Atmoic, Inc., Cambridge, Mass. (UN4-7420) Evaporograph.
(Ref. 7.14)

In the Evaporograph the thickness of an oil film being condensed on the back of a membrane exposed to incident radiation is a function of the point-to-point image temperature. The best temperature sensitivity experienced under carefully controlled laboratory conditions is about 0.5°C which is a considerably less than the theoretical sensitivity. This is probably marginal for our use. Further, at room temperature, the instrument is fairly slow, requiring about 15 seconds at room temperature for differences of a few tenths of degrees and considerably longer for smaller differences. Another difficulty with this instrument is that it produces only pictures, which are difficult to use quantitatively.

II. Radiation Electronics Company, Ill., Thermopan.

This company has two basic types of scanning radiometers, a line scanner, the TP-2, and an area-or-line scanner, the TPA-5. These are made up, on order, and take about five months to build. They are not standardized so that there is no firm set of characteristics. A good example of their best instruments is a special high-speed system built for Redstone Arsenal, with the following characteristics.

Diameter Collecting Mirrors:	6"
Focal Length:	20"
Angular Resolution:	1 mrad.
Field of View:	5° x 5°
Frame Rate:	20/second
Spectral Bandwidth:	2-9 μ
System Sensitivity:	$4 \times 10^{-10} \text{ W/cm}^2 (9\mu)$

7.14 McDaniel, G.W., and D.Z. Robinson, Thermal Imaging by Means of Evaporograph, Applied Optics 1, 311-324; May 1962

~~SECRET~~

~~SECRET~~

Detector:	Cu-Doped Ge
Cooling:	Liquid N ₂ Transfer System
Range of Focus:	500' to ∞
Display:	Direct Video on CRT
Auxiliary Output:	Tape Recorder
Oper. Temperature Range:	32°-110° F.

The line rate is 2000/sec. Any of four filters may be remotely positioned in front of the detector. The temperature sensitivity is on the order of 0.05°-0.1°C but is a strong function of the scanning time. Either the basic instrument, or one of the special jobs such as the above could be applied in a static test program but would have to be borrowed unless the approximately five months' waiting time were tolerable.

117. Barnes Engineering Company, Stamford, Conn., Messrs. G. Solli, S. Impiombato, and F. Wilks, July 17, 1962.

The purpose of this visit was to survey the availability of instruments for the investigation of the radiative characteristics of disturbed ponds.

It was reported in an earlier DRC paper that the only available two dimensional infrared scanner was the Barnes Model 12-600 Infrared Camera. This instrument has very high (1-mrad) resolution. It is capable of producing either a 20° x 10° or 10° x 5° picture but the frame-time is rather long: 13 minutes for the 20° x 10° frame. Since the resolution required for controlled experiments is on the order of 10 mrad, and this is attainable with the instrument, the camera could be advantageously used in the experiments if it were possible to increase the scanning rate by at least a factor of 10. As it turned out, the scanning mechanism has been designed for compactness and an increase of the scanning rate even by a factor of two is questionable.

-7.98-

~~SECRET~~

SECRET

Nevertheless, Barnes Engineering promised to evaluate this possibility and to determine whether there is any restriction such as the orientation of the camera, when it is used at twice its normal scanning rate. Even if this higher scanning rate is feasible without restriction, it appears probable that the infrared camera were a desired instrument only if the disturbance would have an unexpectedly sharp temperature-gradient in a very short distance and a very detailed investigation was justified. (Characteristics of the Model 12-600 are given on the next page.)

The instrument can be purchased for \$25,000 or rented for a minimum time of one month for 10% of the sales price. For rentals of up to 6 months 75% of the rental price is applicable to the purchase price.

The equipment is normally used with a Polaroid camera but a paper chart recording displaying received radiation vs. time per scan line is available.

Barnes Engineering Company has designed and is producing, "Portable Radiation Thermometers" (Model 14-310). This instrument is a radiometer whose design is based on the principle of a continuous comparison of target radiance (more precisely, irradiance from the target) with the known radiance of a built-in black-body reference. The output of the radiometer is displayed on a panel meter calibrated in degrees Fahrenheit; however, the instrument is readily adaptable for use with pen recorders.

The Radiation Thermometers come with a number of modifications whose exact characteristics depend on the desired temperature anywhere in the range from -40°F to 1500°F . The model whose temperature-range is from $+15^{\circ}$ to $+212^{\circ}\text{F}$ has an absolute accuracy of $1\text{-}1/2^{\circ}\text{F}$ at a response time of 20 milliseconds. Since this instrument would facilitate "point-by-point" measurement

of the surface-temperature of the pond, a few seconds response-time would be a good match to the speed with which manual orientation of the tripod-mounted instrument could be accomplished. Thus, a temperature sensitivity of about 0.1°K could be attained in the reduced signal-band. The instrument can be obtained with a field of view of $1^{\circ} \times 1^{\circ}$; it operates in the spectral region between 8 and 13 microns so that it could be equally well used in daytime or night. It consists of an "optical head" weighing about 3 pounds and of "main electronics" weighing about 12 pounds. These units are stored in two carrying cases each 6-1/2 x 6-1/2 x 10-1/2 inches. The power-requirement is 105-125 volts ac, 60 cycles, 15 watts. The price of the instrument is \$1775-, the delivery-time is 30 days. It is felt that a very thorough investigation of the radiative characteristics of small bodies of water could be made with these instruments.

BARNES MODEL 12-600 INFRARED CAMERA SPECIFICATIONS

PERFORMANCE

Scanning Data:
 Width^a----- 20°
 Height----- 5° and 10°, selectable
 Time^b----- 13 minutes

Picture Resolution^c
 For 20° width----- 350 elements/line
 For 10° height----- 176 lines

Target Temperature Range----- -170° to +300°C

Picture Temperature Range (Black to White):
 Minimum Range^d----- 4°C
 Maximum Range----- 150°C

Smallest Detectable Temperature
 Difference in Picture:
 In 4°C Range^d----- 0.5°C
 In 150°C Range----- 10°C

Absolute Accuracy----- $\pm 5^{\circ}\text{C}$

~~SECRET~~

BARNES MODEL 12-600 INFRARED CAMERA SPECIFICATIONS (Cont'd)

OPTICAL

Type of System	Cassegrain Reflecting
Diameter.....	8" (Primary Mirror)
Focal Length.....	12"
Effective Aperture Ratio.....	f/1.9
Range of Focus ^a	1 foot to infinity
Detector Data ^f :	
Size.....	0.3 x 0.3 mm
Field of View.....	1 x 1 mil

ELECTRICAL

Line Voltage.....	115 volts, 60 cps, single phase
Power.....	400 watts

^aOn special order, the instrument can be furnished with a 10° scan.

^bThis scan time is for a 20° x 10° picture area. Scan time for the 20° x 5° field is 6.5 minutes. In the 10°width model, scan times for the 10° x 10° and 10° x 5° fields are 6.5 and 3.25 minutes, respectively.

^cFor a 1 x 1 mil detector field of view.

^dThe use of a germanium-immersed thermistor detector provides a minimum picture temperature range of 1°C, in which the detectable temperature difference is 0.1°C.

^eThis specification indicates the distance between the target and the front of the camera. Considering the additional path length of the folded optical system, the actual distance to the focal plane for a target 1 foot from the camera is 2-1/2 feet.

^fThis data is for the standard unimmersed thermistor detector furnished in the instrument. The germanium-immersed thermistor has a 0.1 x 0.1 mm flake and a 1.3 x 1.3 mil field of view. Immersed and unimmersed detectors with other fields of view can be furnished.

7.4.2 Basic Data Experiments

It appears that practically no quantitative, reproducible data exists on surface (thin-layer) temperature-cycles, or on the radiative character of

~~SECRET~~

the surface of stagnant or disturbed bodies of water. A careful library search of likely places has turned up only a few references and U.S. Hydrographic and similar surveys have not been helpful.

This strongly suggests the necessity for controlled measurements. A simple approach to uncover the essential data is described in the following; different experiments to accomplish the same ends are, of course, reasonable.

7.4.2.1. Parameters of Importance

People wading through normally stagnant bodies of water may cause a relatively strong mixing of the water that exhibits a characteristic vertical temperature distribution. The mixing then results in a disturbance of the temperature of the water surface.

The detectability by infrared means of such a disturbance is directly dependent on the temperature difference between the disturbed and undisturbed water surfaces and on the spatial extent of the former. When the emissivity of the surface also changes with the disturbance, the change in the product of (temperature x emissivity) is the determining quantity. Such a change is conceivable, for instance, with algal water.

Since the duration of such a difference will be finite, detectability will be also limited in time. Consequently, the quantity of interest is the magnitude of temperature difference as a function of space and time. This quantity will be a function of many variables, such as:

- a. Time of the day
- b. Meteorological conditions (clear or overcast sky, temperature, humidity, wind, etc.)

- c. Optical quality of water (spectral absorptivity, reflectivity, and emissivity).
- d. Spectral absorptivity of the bottom.
- e. Plant and animal life and residue.
- f. Depth
- g. Magnitude of (mechanical) disturbance.

In order to experimentally determine the effect of these parameters, that would also facilitate a comparison with theoretical calculations, it is essential to conduct a basic measurement program. The following types of instrumentation and set-ups may be employed to determine these parameters under a variety of conditions and to the degree necessary for initial estimates:

7.4.2.2. Experimental Set-ups

The simulated rice paddy is a controllable-depth simple pool with provisions for producing a disturbance similar to that caused by a person or persons wading through. It should be outdoors, as sun-driving and evaporation effects are important and it should be possible to alter the bottom-covering easily. The pool should be large enough that the transient effects of passage are no more important than they would be in the field.

Suitable experiments may be conducted in a pool of about 14 ft x 24 ft x 3 ft which may be of gunnite construction and include provisions to drain off and replenish the water conveniently. Thus, the depth of the water and the composition of the bottom (mud) could be varied.

Thermocouple sensors would serve for the measurement of the vertical temperature distribution in the water. The use of thermocouples would facilitate accurate differential measurements as well as the measurement of

absolute temperature. Four thermocouples at suitable spacings would provide for the establishment of the temperature profile at one location. The uppermost measured point of the profile would be about 1" - 1/4" below the surface, depending on the wind conditions. The temperature would be measured to an accuracy of $\pm 0.1^{\circ}\text{K}$ and recorded by self-balancing recording potentiometer.

Air temperature, relative humidity and wind would be measured by conventional instruments.

The paddy is observed by a radiometer from a tower (or possibly a cliff), with a scanning or non-scanning radiometer as seems most appropriate. In addition water temperatures should be observed directly at a number of points.

There follows a brief discussion of two alternative modes of observation which were examined.

The discussion is aimed at the description of geometrical conditions under which the disturbed state of the surface temperature of a body of water can be measured in controlled experiments to simulate certain phenomena that are expected to prevail in real situations. The body of water that has to be simulated is a flooded rice paddy; the disturbance that has to be simulated is that which might be caused by people having waded through the paddy. The present interest in details of the disturbance is limited to the extent that could be detected by airborne thermal mapping.

In addition to the geometry of the experimental measurements, the feature of an equipment best suited for the measurements and, alternative measurements possible with other equipment will be pointed out.

In order to measure the temperature-distribution with a spatial resolution of r_c feet across the disturbance, the following approximate relation between r_c and the slant range to the radiometer (R_o feet), look-angle to the resolution element (σ_o degrees) and the instantaneous field of view of the radiometer (w milliradians)² must be satisfied (see diagram):

$$\frac{R_o}{\cos \sigma_o} = \frac{r_c}{w} \times 10^3 \text{ (feet)}$$

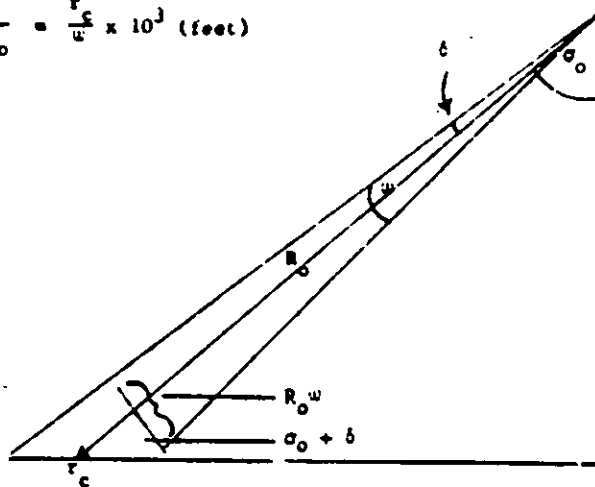

(Note that we neglected δ besides σ_o and took $R_o w$ as the subtended resolution element.)

In view of the spatial resolution that is achievable under operational conditions (for instance, 2-mrad angular resolution and 1500-foot flight altitude: 3 feet at vertical look), a spatial resolution of 0.3 feet for the experiments could be considered. For reasons of a practical setup, we could consider 8-mrad field of view and 40° look angle. Then, the required slant range, R_o , is about 30 feet and the required height of the radiometer (H) is about 23 feet above the target area.

From this height, a scanning radiometer (infrared camera) of $20'' \times 10''$ scan field, could scan (with a 20° swing from about $\sigma = 28.5^\circ$ to 48.5°) a length of the target field, a_1 , that is

$$a_1 = H(\text{tg } 48.5^\circ - \text{tg } 28.5^\circ) \approx 13.5 \text{ feet, and,}$$

with a $\pm 5^\circ$ swing from σ_0 , a width of the target field, a_2 that is

$$a_2 = 2R_0 \times \text{tg } 2.5^\circ \approx 5.2 \text{ feet.}$$

The spatial resolution along a_2 would deteriorate to about 0.35 foot at 48.5° angle; it would improve to about 0.26 foot, at 28.5° look-angle.

The variation of resolution along a_1 would be even less. Consequently, the variation with look-angle of spatial resolution would not be significant, especially if the scan-line a_1 is oriented parallel to the disturbance. In this arrangement, the center of the disturbance would be observed along about 17 resolution elements. The variation across the disturbance would be observed, on the average, with about 20 resolution elements on both sides of the disturbance.

The resolution discussed above is geometrical resolution; that is, perfect focussing was assumed. Since the slant range in the look-angle region between 28.5° and 48.5° would vary by a factor of about 1.3, the degree of focussing and, with this, the actual resolution and temperature-sensitivity would also vary. Consequently, a programmed-focus equipment would be ideal. Nevertheless, a fixed-focus equipment focussed to the slant range R_0 would probably result in very practical accuracy since the variation in range to the disturbed area can be expected within the depth of focus. Moreover,

the effect of defocussing would be easy to determine experimentally by comparing measurements made with focussing to three different ranges, for instance.

To our knowledge, the only infrared camera that is readily available, is the Barnes Model 12-600. While this camera does have a total field of $20^\circ \times 10^\circ$ (or, $20^\circ \times 5^\circ$) and its temperature-sensitivity of 0.1°C appears well suited for the present purpose, the scanning time is 13 minutes. This time may be excessively long for us. The 13-minute scanning time is, partly, caused by the relatively high resolution: 1 mrad. Although the potential exists to decrease the scanning-time to 1.3 minutes by decreasing the 10° width (about 170 elements) to 1° (17 elements), this could be achieved from a slant range of 150 feet, at a look angle of 60° . But, in this case, the required height of the radiometer would be 75 feet. This height would lead to a costly platform unless a suitable natural terrain (cliff) could be found to locate the camera.

The $10^\circ \times 5^\circ$ model of the Barnes camera would picture an about 13-foot by 5-foot area (from 46-foot height at 60-foot slant range, $\sigma_o = 40^\circ$) in 3.25 minutes. This picture would have, at σ_o , a spatial resolution of about 0.08 foot. Thus, we would again pay with time for not-needed resolution. The camera at a height of 40 feet and at $\sigma_o = 67.5^\circ$, the spatial resolution r_c would be about 0.27 foot and the scanning-time would be about 2 minutes. This time could be reduced to less than 1 minute, if, at 1.3 mrad field of view (germanium immersed detector), provision exists to increase the scanning time by a factor of about 2.

An infrared camera would have the advantage that it can produce a visual presentation of the thermal characteristics of the entire target

SECRET

field, and, simultaneously, it can furnish a radiant-intensity vs. time (scan angle) record of the target field. Unfortunately, the only readily available camera has an unnecessarily high resolution for the present application, leading to excessive times to perform the measurements and/or to a measurement geometry that seems impractical.

An alternative measurement program would use fixed-field radiometer. In this case, selected areas of the target field would have to be measured "point-by-point" or, the temperature variation of a highly important area such as a portion of the disturbance, could be measured during a period of time of interest. The field of view of the radiometer and the geometry of the measurements would be as described earlier. With two identical radiometers, a differential measurement could be made: one instrument would be pointed at the disturbance and the other instrument would be pointed at an undisturbed portion of the target area. Of course, such information could also be derived on a time-sharing basis. The time required for the measurement of one data-point would be determined by the time needed for manual aiming of the radiometer, since signal bandwidths on the order of ten cps or more can be had.

The Barnes camera can also be used as a fixed-field (not scanning) radiometer. In this application, field of views up to 8 mrad x 8 mrad can be obtained by the use of appropriate-size detector.* The detectors are thermistor detectors of essentially neutral spectral response. Since, in field application, the spectral region of detection will be limited by atmospheric absorption to either the band between 3 and 5 microns or to the band between

* The use of a large field of view in scanning mode leads to overlapping scan lines but not to an advantage.

8 and 13 microns, the neutral response of a thermistor detector does not have a particular advantage. The advantage of the thermistor detector is limited to the practical aspect that it does not need cooling.

If we add that the slow response of thermistor detectors is responsible for the long scanning times previously discussed, it appears that a camera with thermistor detector would not be the best choice of scanning radiometer, nor perhaps, of a fixed-field radiometer.

The experiment, preferred after consideration of all factors and on the basis of simplicity, low initial costs, and a somewhat more modest data-handling problem is given below:

The radiance ("temperature") of the water surface would be measured with Barnes "Portable Radiation Thermometer," Model 14-310. This instrument is essentially a radiometer with a built-in black-body reference, operating in the spectral region between 8 and 13 microns. The instrument may be had with a field-of-view of $1^\circ \times 1^\circ$ and a temperature sensitivity of 0.1°K at a response time of 1 or 2 seconds. Two radiometers would be used simultaneously, on an about 20-ft high wooden platform located at some 8 ft from the edge of the pool. (Figure 7.4.1) Thus, the slant range to the center of the pool would be about 25 ft and the subtended areas would be about 0.4 ft x 0.46 ft.* Consequently, a 0.46-ft wide annulus could be scanned by rotating a radiometer, at a constant depression angle, around a vertical axis. In about one minute of time, one half of the annulus could be measured.

* Both the accuracy of the temperature measurements and the spatial resolution have been chosen to match the capability of airborne IR scanners. This is, typically, 0.1°K at 1-mrad square field-of-view or 1 square foot at 1000 feet.

SECRET

In measuring the temperature of a disturbance, one radiometer would be pointed at the center of the disturbance while the other radiometer would scan the annulus. The output of the first radiometer, the difference of the radiometer outputs and the angular position of the scanning radiometer would be recorded on a strip-chart recorder. Thus, the temperature of the scatter of the disturbance vs. time would be continuously measured; the spatial extent of the disturbance vs. time would be measured in time-sharing.**

The radiometers would also serve, from time to time, for the measurement of sky temperature.

A calibrated thermopile would facilitate the measurement of insolation and a conventional illumination meter would be used for the measurement of the transmissivity of the water with various concentrations of mud.^α

In order to assure reproducibility, a simple mechanical device would serve to introduce the disturbances. This device would be perhaps a cylinder with radial fans, that would roll on the bottom of the pool when pulled by means of a rope. The cylinder would be about 1 to 1-1/2 ft long and large enough in diameter as not to completely submerge in the water; guide ropes could assure an approximately straight path of travel. The final form of the device would be governed by the criterion of producing disturbances that are similar to those caused by people.

** Alternatively, an undisturbed area of the annulus could be measured in continuum and the disturbance could be scanned. Moreover, the angular size of the annulus and its respective portions on both sides of the disturbance, are possible variations in the technique of measurements. Optimum technique would be determined experimentally.

^α Ideally, the spectral distribution of these quantities should be measured. Nevertheless, the measurements can be reduced with good accuracy to furnish the necessary information.

The site of the pool would be properly fenced and suitable storage facility provided for the instruments.

7.4.2 3. Program Plan

The experiments could be carried out in two phases in six-months' time, as follows:

Phase I. Preparation

This phase would require two calendar months, constituted of the following activities:

- a. Review of requirements and detailed specification of instrumentation and set-up. Detailed program plan. First and second weeks.
- b. Selection of test area. [Negotiation of lease.] First through third weeks.
- c. Construction of pool with mechanical disturber, radiometer platform, storage shack, fence. Fourth through eighth weeks.
- d. Assembly and calibration of instrumentation. Second through eighth weeks.

Phase II. Experiments

The experiments would require four calendar months. During this time, the measurements would be taken, data reduced and evaluated to establish the requirements for detection by airborne surveillance gear.

The measurements would be performed in three categories as follows:

1. Installation and checkout of the instrumentation. One week.
2. Establishment of the daily cycle of the vertical temperature excursion, including surface temperature, of undisturbed water.

These measurements would be carried out around the clock, in order to determine the time of minimum excursion that is potentially the time of least detectability.

3. Characteristics of disturbances. These measurements would be carried out at critical times of the day to facilitate establishment of the daily variation of detectability.

The second and third categories would include measurements made with several different types of bottom and, if possible, with some growth in the pool. Tenth through twenty-fourth weeks.

The status of the program and partial results should be assessed on a monthly basis. A final report should be in hand by the end of the sixth calendar month.

This program would require 4-1/2 man months of senior and 5 man months of junior effort and costs for the experimental set-up should run about as follows:

	<u>(\$-K)</u>
I.1. Lease of property for six months, \$150/1 month (if necessary)-	0.90
I.2 Construction of:	
Pool-----	1.70
Mechanical Disturber-----	0.40
Platform-----	0.35
Storage shack-----	0.20
Fence with gate, \$1.75/ft-----	0.30
I.3 Water connection, powerline, pump. mud-----	0.75
I.4 Restoration of property to original condition, labor to change mud, insurance, contingency-----	<u>1.40</u>
	\$6.0

SECRET

(S-K)

II. Instrumentation	
Radiometer, 2 each at 1.8K-----	3.60
Recording potentiometer-----	2.20
Strip-chart recorder-----	0.90
Calibrated thermopile-----	0.35
Miscellaneous (illumination-meter, readout potentiometer for scanning-radiometer, scan-drive, tripods, etc.)-----	0.75
Meteorological gear and miscellaneous items-----	<u>2.00</u>
	99.8

7.4.3. "Quick-Fix" Experiment

7.4.3.1. Introduction

Informal arrangements were made with University of Michigan (Mr. J. Morgan) for a "quick-fix" experiment involving thermal mapping of a nearly shallow pool. This was in lieu of a preferred rental of commercial equipment. An account of the experiment is given below. Unfortunately, schedule difficulties arose which prevented running the exercise under fully controlled conditions and there were frustrating equipment failures. These and lack of experience with this type of observation made interpretation difficult. It has not been possible to repeat the experiment. Much thanks, nonetheless, is due to University of Michigan personnel for their efforts.

7.4.3.2. Equipment for Experiment

- a) Temperature Probe Set* :
- (a) 5 (five) temperature sensing elements (probes)
- (b) 1 (one) readout instrument

* Two of these sets were purchased and one is now in use in Thailand. (See 3.6). Satisfactory results were obtained in tests in Santa Barbara.

SECRET

- (d) 1 (one) probe mount
- (e) 1 (one) thermometer (25 to 125°F) and
1 (one) hygrometer with instructions
- (f) 1 (one) carrying case

(a) Each temperature sensing element is a thermistor embedded in a glass-bead, and mounted, water-proof, in a steel probe with leads 20 ft in length. The thermistor has a negative temperature-coefficient. Its resistance decreases with increasing temperature, by an amount of the order of 1 per cent per 1/2°F. The resistance of the thermistor is of the order of 6000 ohms at 50°F and about 1000 ohms at 140°F. Consequently, the resistance of the leads is negligible compared to the resistance of the thermistor. The leads from the individual probes are connected to an 11-prong plug that connects into the readout instrument.

(b) The readout instrument is a dc wheatstone bridge with a (-50)-0-(+ 50) microampere meter as indicator. The bridge has three different alignments for zero bridge-current that corresponds to the resistance of the thermistors at 66°F, 96°F and about 125°F temperature, respectively. At any other resistance of the thermistors, a bridge-current prevails. Conversion from bridge-current to temperature is facilitated by a calibration table.* The table has three columns for the three alignments that result in three temperature ranges. These are:

50°F - 80°F
80°F - 110°F
110°F - 140°F

* Time limitation prevented furnishing the meter with scales directly calibrated in temperature.

~~SECRET~~

At the "off" position of the Temperature-range the bridge is open (unenergized).

The bridge is energized by two Eveready E-12 Mercury cells, providing for more than 1000 hr of operation. The condition of these cells can be checked at the "30-Test" position of the Temperature-range switch that connects a fixed calibration resistor to the bridge. The bridge-current that must flow in this case is -30 microampere. A meter-deflection to the left of the mark indicates discharged cells. The cells are accessible for replacement through the base-plate of the instrument case. Note that correct "calibration-current" is an indication of proper operation of the readout instrument, only. For a checkout of the entire instrument, the probes have to be inserted in a constant temperature bath, together with a mercury thermometer and the reading from each of the probes must be compared with the thermometer reading. Readings within $1\mu\text{A}$ indicate correct operation.

The bridge operates in an ambient temperature-range from -40°F to $+140^{\circ}\text{F}$. Nevertheless, the readout instrument should be shielded from direct sunlight and not placed on moist ground.

Due to the thermal inertia of the thermistor-probe and the delay in meter response, the response-time of the equipment is of the order of a few seconds. Consequently, the measurement of the temperature of five probes will require about one-half to three-quarters of the minutes of time.

Any one of the five probes may be measured at a time, depending on the position of the "Stations" switch, and, when the "Temperature-range" switch is on one of the ranges.

-7.115-

~~SECRET~~

The absolute temperature sensitivity of the instrumentation is about $\pm 1/2^{\circ}\text{F}$. However, a relative accuracy of about $\pm 1/4^{\circ}\text{F}$ can be obtained by estimating the meter-deflection to within quarter of a division.

(c) The probe-mount is provided to keep the thermistor-probes at a constant relative position in (a vertical) line. The mount is a 3-ft long hardwood bar with holes, to receive the probes, at one-inch intervals. Each probe is secured in a hole with a rubber grommet placed on the narrow end of the probe and jammed against the bar.

A wooden flange with collar attaches to the lower end of the bar to prevent the bar from sinking into mud. The bar is secured in the flange by a 2"-long 8/32 machine screw (supplied). To prevent the mount from floating, the flange has to be weighted. A 10- or 15-ft long bamboo pole may be attached to the upper end of the bar to facilitate insertion (lowering) of the mount into the water from the edge of the pond. Once the probe-mount is inserted in the water, the bamboo-pole may be set and secured on the bank of the pool to assure a steady position of the probes. The stability of the probe mount may be increased by an additional pole fastened to form a "Y" with the first pole.

b) Surveillance Equipment:

The University of Michigan aircraft, equipped with an AAD-2 scanner and a medium aperture radiometer, similar to the equipment to be used in the routine terrain mapping experiments, was to be employed. The scanner was to employ total InSb ($1/2 \text{ mm} \times 1/2 \text{ mm}$ and $1/4 \text{ mm} \times 1/4 \text{ mm}$) and Ge-Cu ($1/4 \text{ mm} \times 1/4 \text{ mm}$) detectors. The resolution of this scanner with $1/2 \text{ mm} \times 1/2 \text{ mm}$ detectors is about 3 (milliradians)².

~~SECRET~~ ~~SECRET~~

7.4.3.3. Experiment

On the 19th and 20th of September 1962, thermal maps were made of a shallow, natural pond, in its normal state and disturbed by walking personnel. The primary objective was that of gaining first-hand experience with the problems of using thermal mappers against small water targets and small apparent temperature differences.

One daytime and one nighttime mission was scheduled for each day. The target of the mission was a natural pond south of Ypsilanti, Michigan. Adjacent to Willis Road, this pond is about 1-1/2 to 2 miles west of U.S. Highway 23. The shape of the pond is roughly elliptical with an estimated 80 to 90 yard-long major axis and 45 to 55 yard-long minor axis. The depth of the pond is, on the average, about two feet, occasionally dipping to three feet. There is algae on the water periphery in widths as great as 10 feet and a growth of reed around the edge of the pond, except for the bank along the road.

Numerous thermal mappings of this pond, both in its natural and disturbed state, were scheduled for each mission, primarily from an altitude of 500 feet. Plans were to explore the effect of spatial resolution as well as the effect of spectral region. During the missions, the vertical temperature distribution at a selected location in the pond was measured from a small aluminum boat by thermistor probes. In the daytime, from about 9 o'clock on, a total of about 3/8 of the sky was covered by small patches of clouds of rapidly changing configuration. Surface winds with velocities up to 20 knots were encountered, making for generally poor conditions. In contrast, the nights were clear and calm. Air and water temperatures were as follows:

-7.117-

~~SECRET~~
~~SECRET~~

~~SECRET~~

	<u>September 19</u>		<u>September 20</u>		
Local Time.....	1531	2030	1100	2115	2145
Air Temperature, °F.....	60	45	52	43	41
Water Temperature, °F....	68	64	57	59	59

Due to intermittent insolation, the heating cycle was irregular. In addition, high wind in the forenoon of the second day made surface-layer temperature measurements difficult. On that night, however, repeated observations indicated that a temperature difference of about -1°F (at 2136) and about $-1\text{-}1/2^{\circ}\text{F}$ (at 2146) existed between layers at about $1/4''$ and $10''$ below the surface. The temperature reading on the probe closest to the surface was made with the boat slowly rocking so that the probe approached the surface without emerging. During the opposite swing of the probe, the temperature difference decreased to about $1/2^{\circ}\text{F}$ and even to zero. (Note that the probes were on a floating mount at a distance of about 4 or 5 feet from the boat, while the leads from the probes to the readout instrument in the boat, were submerged in water.)

It is therefore reasonable that people wading in the pool caused a temperature differential of at least the same magnitude between undisturbed and disturbed areas. After the first mappings a number of people tramped energetically around the boat in a roughly circular pattern but the hoped-for "wake" was not seen in the photographs.

As is often the case this first attempt at a complex measurement in the field suffered certain misfortunes. First, failure of a drive-belt on the scanner caused cancellation of the first afternoon flight.

~~SECRET~~

~~SECRET~~

On the night mission of the same day, a leak in the Dewar of one detector and noisy leads on the other caused very poor signals. A substitute detector was tried without obtaining any improvement. Consequently, no usable mapper data were obtained on the first day. Further, although the substitute detectors used on the second day may have developed usable information, the in-flight film recording was made at a setting that accommodated the variation in signal level from the entire scanned field. That is, the daytime film records show the pond in an unexpanded gray scale; considerably less than the available density range of the film has been utilized, for the pond. The nighttime records, in addition, have the pond placed on the upper knee of the gamma curve where the slope of the curve might be less by a factor of 2 or 3 than in the middle. This means that differences in signal level larger by the same factor can only be distinguished at this portion of the gamma curve as a step in density. For example; at a density range that consists of 30 steps, and at a temperature range of 15°K , a temperature difference of one-half degree would cause a step in the middle of the gray scale; whereas, only as much as 1°K or 1.5°K would be discernible in the high-density region of the film. These characteristics of the in-flight film recording and probably inferior sensitivity of the substitute detector* may explain the fact that no wake (or personnel) can be identified in the maps although the boat is identifiable.

Raw data is available on photographic negative and magnetic tape at University of Michigan.

* Although no firm data are available, it appears probable that the temperature sensitivity was worse than 0.5°K .

~~SECRET~~

SECRET

7.4.3.4. Critique

This experiment, like many field exercises, suffered from a number of deficiencies from which lessons can be learned. These were:

- a) Schedule problems--original plans called for a more leisurely mapping exercise which was compressed because of upcoming priority experiments (i.e., Operation Tropicán, etc.);
- b) Poor coordination--due to a mutual misunderstanding, no field reference standards of temperature were provided and there was no time to obtain these;
- c) Equipment--failure--(as noted earlier);
- d) Poor conditions--on the particular days open for test the meteorological conditions were poor.

These fairly typical problems fortify an opinion that even a simple field experiment needs time to mature.

Examinations of original photographic negatives showed no traces (wakes) that could positively be correlated with the known paths of personnel. This failure was tentatively assigned to the fact that the mapped pond, in the nighttime pictures, was overexposed, causing an apparent increase of the detectable temperature-difference. Such photographs as were obtained already have been forwarded to ARPA in DRC monthly reports.

On the 11th of November, 3 x enlargements of representative in-flight imagery acquired during the experiments were received from the University of Michigan.

The water, in the night, was warmer than the terrain, the pond (and the road) appears, in these positive pictures, much lighter than

-7.120-

SECRET

~~SECRET~~

the terrain.

The point is that more detail of the pond surface structure would be seen if the negatives had been made with lesser exposure. Even so, the boat in the middle of the pond is clearly seen in both pictures; moreover, one has the impression of seeing structures of the pond when inspecting the pictures at a slant angle from arm-length. It is believed that other enlargements made at a higher exposure--so that the terrain would appear almost completely black--could reveal whether this impression is correct or not. Of course, this purpose could be best served by new negatives, made, at optimum settings, from the tape recordings. However, the responsibilities of Project Tropicana have prevented the making of such enlargements or new negatives from the magnetic tape-recordings. It is hoped that the University will find time later for further evaluation. To date no additional information has been received.

7.4.4. Summary

On reasonable, if not provable, grounds it is concluded that (1) Personnel transiting through stagnant water may cause a difference in the radiative character of the water surface, in a manner analogous to the formation of ship wakes; (2) Detection of such changes, and especially their patterns may be useful in anti-guerrilla operations; (3) Since the quantitative characteristics of the postulated phenomenon (i.e., intensity, extent, persistence, and observability) are not known, they should be determined by a basic measurement program.

During this study an unsuccessful quick-fix experiment with a thermal mapper was tried. Existing thermal maps of water surfaces made with

-7.121-

~~SECRET~~

CONFIDENTIAL

7.5. Comments on Other Applications

Other applications of IR may be of some interest in anti-guerilla work. Night-time viewers weapon sights, scanners, etc., for military applications have all been the subject of developmental work. Since, in this study, the few novel applications of IR received most of the effort, the treatment here is cursory and brief. Ideas for other applications or study are discussed in 7.5.1. Some information on existing devices was obtained by visits to responsible laboratories but for the most part, a survey of current state-of-the-art was attempted through acquisition of reports. Such data as were obtained are given in 7.5.2. and 7.5.3.

CONTENTS

7.5.1. General

7.5.2. Developed Equipment

7.5.3. Evaluations and Tests

7.5.1. General

Night-time viewers and scanners, including battlefield surveillance devices, intrusion detectors, etc., may be of utility in certain anti-guerilla operations depending on their performance, weight, and other factors. This is a general question of requirements versus feasibility which seems to require a comparison of operational needs with the performance of existing equipment, and the feasibility of superior equipment, a comparison which has not yet been made. In Table 7.5.1, in the next subsection, a list is given of developed equipment and its expected characteristics. This may be of some use in the Agile program as either (1) the

CONFIDENTIAL

~~CONFIDENTIAL~~

equipment has been already evaluated and results may cover the cases of interest for Agile, or (2) the equipment, even if dormant, may still be in existence and available for necessary tests.

Two thoughts on less typical and somewhat far-out applications occur to us and are given here without analysis. First, in looking for trails or corridors under the rainforest, it may be that IR mapping and multicolor photography may be useful. Trails or streams may result in a slightly different average equilibrium temperature distribution on the forest top. At an instantaneous field-of-view of 2 mrad the sensitivity of state-of-the-art thermal mappers is such that about a 0.1% change in the product (emissivity X temperature) may be measured. If average temperature gradients occur across trails or streams, are of this order, or greater and are not lost in fluctuations, they may be seen in the output of properly processed mappers. A data processing system designed to emphasize isotherm representation might be helpful here. Also, as seen in reference 7.15, rather subtle differences in foliage can be seen when pictures are taken with panchromatic color, infra-red, and camouflage film. Different species can be identified and, in the same species, sick and healthy trees (which may have reflectivities differing by a factor of 10) can be differentiated. Such photographic contrasts may be used for two purposes --- to deduce the general nature* of the forest, and with other data, infer its characteristics more accurately. (It may then be possible to infer the nature of the ground level conditions precisely enough to

7.15 Manual of Photographic Interpretation George Banta, Inc.,
Menasha, Wisc. 1960

* For example, whether a given region contains many randomly located species and, hence, is primary rainforest, or contains species in stands and, hence, is not.

-7.125-

~~CONFIDENTIAL~~

CONFIDENTIAL

locate "corridors"); and to estimate the stand density directly from crown closure (or crown cover) and height measurements (and then deduce the probable ground level conditions). It is clear that not enough data are on hand concerning S. E. Asian forests^{**} to evaluate the utility of these ideas.

It is suggested that terrain mapping and photography exercises be carried out on selected areas of S. E. Asian "jungle" of different types, containing some well-known trails and streams to see if detection can be accomplished. The data should also be analyzed to determine the degree of accuracy attainable in predictions of the characteristics of the ground level.

[The other notion is that, if it is really true, that jungle living for a short period produces visually detectable changes in skin color, whether a more sensitive inspection device might be made which would indicate, in a variety of natural skin shades, lack of exposure to sunlight. On balance this seems unlikely, but is not known.]

7.3... Developed Equipment

A very large variety of IR equipment for all sorts of military purposes has been developed in the past few years. With few exceptions not much of the combat surveillance equipment has gone into production. On the basis that it may be desirable in Agile, to test some of these devices, for strategic hamlet, outpost or other obvious uses, a list is given in Table 7.3.1 of equipment which might be applicable, with enough data to enable an interested party to locate the equipment.

** U. S. Forestry Service was queried for data but none were available.

CONFIDENTIAL

Table 7.5.1 Pertinent Military Infrared Equipment (Ref. 7.16)

<u>Identification or Name</u>	<u>Contractor & Service</u>	<u>Type</u>	<u>Probable Status</u>
<u>Viewers</u>			
AN/AAR-2	G. E.	Passive Binocular - 2-1P25D ICTs*	
T-6A	American Optical Buffalo, ERDL	Head mounted binoculars -2-6929 ICTs - requires IR searchlight	Adopted by Army
T1-CO	American Optical Buffalo, ERDL	Like T-6A but for close work like map reading	Field test
EM-18	Wollensak DA44-004 KMC 2651 ERDL	Handheld binoculars - require IR illumination - ICT	Field test
AN/PYS-6	Raytheon, Santa Barbara SCEI	Tripod mounted radar/active IR for moving targets. Personnel range 400 yd.	Dormant
T-5	Hanson, Garrill, Brian Glen Cove, N.Y. ERDL	Metascope imager ICT6929	Production
AN/AAR-5(XK-1)	Q-O-S Corp., N.Y. BuShips	Surveillance binocular - hot or illuminated objects 2-ICTs 6032-A	Dormant
<u>Weapon Sights</u>			
IR Weapon Sight	Raytheon, Santa Barbara ERDL	Basic weapons 6914 CT-300 yds. range	} Production contract let for a quantity of one of these
T-2 Weapon Sight	Raytheon, Santa Barbara ERDL	Basic Weapons 6929 CT-300 yds. range	
* Image Conversion Tube			
7.16 Military Handbook	<u>Infrared Equipment Vol I & II</u>	BuShips MIL-HDBK-250	Sec.

-7.127-

Table 7.5.1 Pertinent Military Infrared Equipment - Continued

Identification or Name	Contractor & Service	Type	Probable Status
R-579(XE-1)/PAR	Raytheon, Santa Barbara BuOrd	Passive intrusion detector < 1° field-of-view 2 element thermistor bolometer - personnel 400 yd.	Dormant
R-579(XE-2)PAR	Eastman Kodak BuOrd	Similar to above	Dormant
R-579(XE-3)PAR (AN/PAR-4)(XE-3)	Eastman Kodak SCL	Similar to above -4-5 mrad 50 lbs.	Dormant
R-579(XE-4)&(XE-5)	Eastman Kodak SCL	Similar to above 50 + lbs.	Tested
<u>Scanners</u>			
AN/PAS-1	NRL	Tripod passive, for detecting personnel & vehicles for IR	-----
Scanrod T-2	Servo Corp. New Hyde Park, N.Y. USARDL	Tripod passive for personnel & vehicles, personnel 500 - 1000 yds. - thermistor bolometer - 70 lbs.	Evaluation

CONFIDENTIAL

-7,128-

~~CONFIDENTIAL~~

7.5.3. Evaluations and Tests

Only a few reports of evaluations and tests of military equipment were received during the contract. Usually the reports on thermal map interpretation (e.g., Ref. 7.17 and 7.18) are in such condition, (due to reproducing processes) that they are of little use, as the fine details of the map are lost. Some paraphrased comments from the evaluations at hand are given below:

a) The AN/AAS-5 (XE-1) Infrared Detecting Set (Ref. 7.19)

-----The gaseous N₂ cooling system is unreliable, relay and tube failures are frequent, images are smeared by CRT blooming, and the film image is unsatisfactory. In addition, parts and connections work loose and the equipment is too large and heavy.-----

For each deficiency corrective action is suggested but it is not known whether the equipment was reworked by the service. As noted earlier 5 of these equipments were bailed by U. of Michigan and have, with extensive reworking, been made to yield very good results.

b) The AN/GAD-1 Ground-based Passive Infrared Detector (Ref. 7.20)

-----This equipment, by HRS-Singer, was originally requested (Jan 1959) as a portable battlefield surveillance device with visual display. Difficulties in design were encountered and

- 7.17 Currie et al The Interpretation of Infrared Aerial Reconnaissance Data
NSR-369 (Bendix Systems Division)RADC-TR-60-240 Dec 1960
- 7.18 Currie et al Infrared Interpretation Manual - Tactical Targets
NSR-368 (Bendix Systems Division)RADC-TR-60-241 Dec 1960
- 7.19 (U) Operational Evaluation of AN/AAS-5 U. S. Army
Electronic Proving Ground USAEPG-SIG930-91 June 1959(Conf.)
- 7.20 Fulton, R. (U)Final Report--Technical Evaluation of Infrared Detecting
Set AN/GAD-1 USAEPG-SIG930-194 Mar 1961 (Conf.)

~~CONFIDENTIAL~~

~~CONFIDENTIAL~~

weight requirements were waived. The delivered weight (January 1960) was 541 lbs.

In performance, even with Ge cells, operators rarely detected personnel at ranges in excess of 100 yds. in good backgrounds. Design reliability was very poor.

The test report recommended that no further effort be expended on this equipment but that improved designs should be explored.

c) Infrared Binoculars (T6A of Table 7.5.1) (Ref. 7.21)

-----"With experience, drivers can operate vehicles at night, using the test equipment, practically as well as by using vehicular headlights."

The Board recommended modifications, to include better filters, but otherwise mainly mechanical in nature. It is believed that a modified version of the T-6A is now standard Army equipment.

d) Use of Infra-Red in Korea (Ref. 7.22)

-----"Best results were obtained with the IR filtered 18" tank searchlight (83 amps at 24 volts) placed about 125 yards to the rear of the M-3 Sniperscope position. The light, with 2-IR filters was just discernible to the unaided eye of an individual who knew its approximate location. Approximate clear weather performance was as shown in Table 7.5.2.

7.21 COMARC Report of U. S. Army Armor Board 1 June 1959
7.22 Ord, J. A. Report on the Use of Infra-Red in Korea HQ. U.S. Army Far East (AD 38094) (Conf.)

-7.130-

~~CONFIDENTIAL~~

~~CONFIDENTIAL~~

Table 7 5.2 M-3 Sniperscope/18" Searchlight Performance

<u>Distance from Forward Position (Yds.)</u>	<u>Identification Possible</u>
75	--3/4" lettering on nameplate of soldier
100-150	--recognize individual
200-250	--sufficient detail for sniper to aim
250-400	--motion detectable

~~CONFIDENTIAL~~

7.6 BACKGROUND PROBLEMS

CONTENTS

- 7.6.1 General
- 7.6.2 Limitation of the Detectable Signal by Background
- 7.6.3 Qualitative Comments
- 7.6.4 Conclusion

7.6.1 General

The limit to the measurement of a physical quantity is set by always-present natural fluctuations (noise). This noise might

- o be a component of the quantity to be measured;
- o be produced by the measuring instrument;
- o originate in the environment of the source and instrument; or
- o originate anywhere in between the source and instrument.

In measurements of radiation an absolute limit is set by the photon-noise of the source-radiation. More often, however, the noise from the target's environment (background) is the limiting factor.

Background noise must always be considered whenever the field of view (f.o.v.) of a radiometer (detection-equipment) is larger than the angle subtended by the target. When the target is as large or larger than the f.o.v., as is the case in thermal mapping the background becomes identical to the target.

In two promising applications of optical techniques to guerrilla-warfare (i.e., fire-detection and wake-detection) however, background-noise does compete with the target-signal.

7.6.2 Limitation of the Detectable Signal by Background

The magnitude of the competition may be derived as follows:

Let,

- σ = f.o.v. of a radiometer (sterad),
- A_0 = effective aperture area of optics (cm^2),
- f = focal length of optics (cm),
- W_T = radiance, effective to detector, of (W/cm^2 . sterad.),
- A_T = subtended area of target (cm^2),
- \bar{W}_B = average radiance of background (W/cm^2 . sterad.),
- $\Delta\bar{W}_B$ = maximum deviation from average radiance of background (W/cm^2 . sterad.),
- R = range to target and background (cm),
- $\bar{\tau}$ = effective transmission of path,

then, when the field of view is determined by the detector, the peak effective power from the target on the detector (i.e., the difference in power with and without the target in the f.o.v.), P_T is

$$P_T = \frac{\bar{\tau} A_0 A_T (W_T - \bar{W}_B)}{R^2}$$

This power has to compete in producing a useful signal, with the effect of the fluctuating component of the background-radiation. The total power on the detector, from this component, ΔP_B is

$$\Delta P_B = \bar{\tau} A_0 (\Delta\bar{W}_B)$$

However, depending on,

- o the waveform of ΔP_B -- which may be the resultant of two components: (1) eventual temporal variations of the background-radiation and (2) time-varying radiation on the detector which arises from scanning across spatial gradients of the background --
- o the signal bandwidth, and,
- o the desired accuracy of the measurement (expressed, for instance, in false-alarm-rate).

but a fraction m of ΔP_B will be effective and this must not be larger than P_T . Consequently, the target can be detected, if $P_T \geq m \Delta P_B$ or,

$$A_T(W_T - \bar{W}_B) \geq \sigma_B^2 \Delta W_B \quad (1)$$

Equation (1) shows that, for a quantitative determination of the background effects, pertinent characteristics of background-radiation (because of ΔW_B) and the specification of the detection-equipment (because of m) must be known. Without these only qualitative treatment, as follows, can be given.

7.6.3. Qualitative Comments

The lower limit of target-radiation, given in Equation (1), and/or allowable upper limit of $m \Delta W_B$ will have different levels in the fire-detection and wake-detection, respectively.

In case of fire-detection, one has to find a "point" as large as a resolution element, in a two-dimensional assembly of a very large number of picture-elements. Or, one has to have an even higher signal when an instantaneous automatic indication of the event of having a target detected, is a

requirement. Consequently, the signal to limiting-noise ratio will have to be relatively high in both cases. All the signs available at present indicate that sufficiently high signal to noise ratio can be obtained. (See 7.2 and 7.3).

In case of wake-detection, one has to find a "line" in a picture. In contrast to a point in the previous case, a line has a unique shape that greatly facilitates discrimination from background ("pattern recognition"). There might be cases when a line is so unique relative to the background-structure that recognition is possible at an unusually low signal-to-limiting noise ratio. Of course, recognition at a very low signal-to-noise ratio requires long time (narrow bandwidth) for evaluation. An "instantaneous" automatic recognition would probably require a much stronger signal than a post-real-time automatic recognition or that demanded visual evaluation of a map. This may especially be the case at the present when the art of automatic pattern-recognition is relatively underdeveloped. (See Section 7.1).

7.6.4. Conclusion

Quantitative determination of the effect of background noise on detectability requires definite values of equipment parameters and operational requirements which cannot be given at present. From qualitative considerations it is estimated that no detrimental background-effect should be expected in fire-detection through direct path with equipment of sensitivity well within the capability of the art. (The effect of weather would be about the same on target-signal as well as on signal from the background.) In fire-detection through indirect path and in wake-detection, the same expectation is much less founded for lack of vital data. For this reason, especially, data on background necessary for evaluating the possibility of indirect detection and for trial detection as suggested in 7.5, should be obtained.

7.7 Choice of Detectors

A portion of this Contract involved judgment as to whether existing equipment could be applied to the anti-guerilla detection problem. This subsection provides an example of some of the work done. Detector selection is discussed because the choice of the best detector for an IR equipment is an art which depends, more often than not, on poorly defined factors, whereas other elements of the system are more routinely defined. A brief comment is given here on a) state-of-the-art in single-element detectors, and b) confidence in predicted performance of imaging detectors. [An Appendix to this section illustrates detector selection and feasibility estimates for equipment using existing components, for line scanners, photography, and image orthicons. The numbers employed for targets and background are somewhat old-fashioned and not particularly relevant to present thinking.]

CONTENTS

- 7.7.1 Contemporary Single-Element Detectors
- 7.7.2 Interpretation of Predictions
- 7.7.3 Summary
- 7.7.4 Appendix: Illustrative Example (Feasibility of Equipment Design)

7.7.1 Contemporary Single-Element Detectors

It is sufficient here to characterize detectors by sensitivity only. Figure 7.7.1a shows the most sensitive detectors available in limited regions of the spectrum between 0.3 and 15 microns. Figure 7.7.1b shows the sensitivity of a large number of detectors responsive in the region 1.5 to 70 microns. [It is not intended to discuss here all the data in the figures but merely to make it available and note that most of the detectors can be obtained, although not

~~SECRET~~

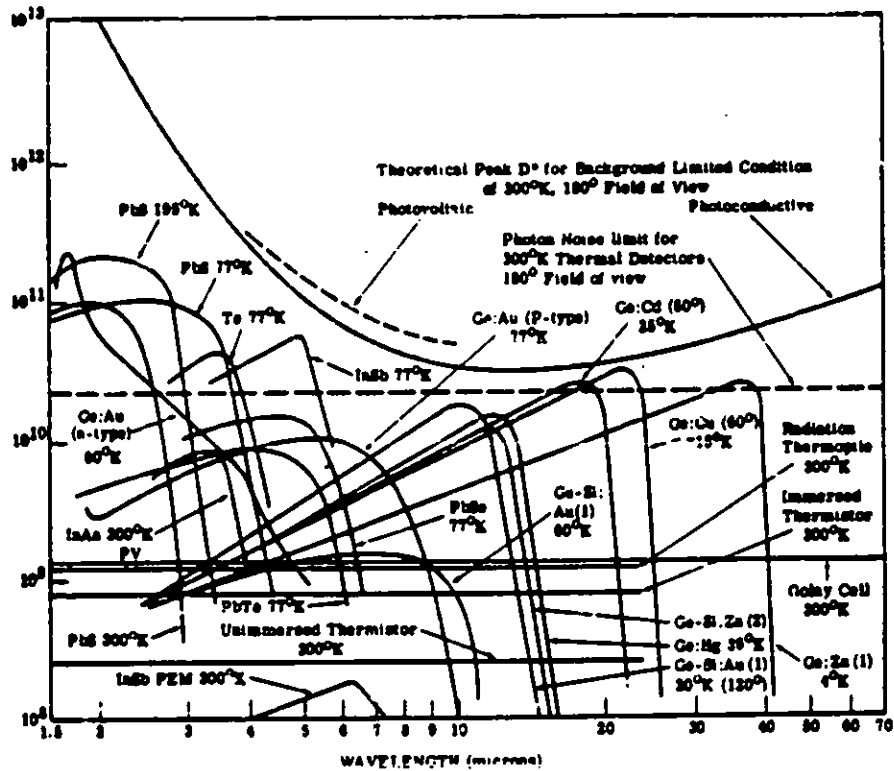

Figure 7.7.1b - Detectivity of Single-Element Detectors for the Spectral-Region between 1.5 and 70 Microns. (Compiled by Institute of Science and Technology, University of Michigan).

~~SECRET~~

~~SECRET~~

always immediately.] Note that figures cover quantum as well as thermal detectors; the quantum detectors further include photoemissive, photovoltaic, and photoconductive detectors. Thermal, photoconductive and photovoltaic detectors can be produced to form an array or a mosaic.

7.7.2 Interpretation of Predictions Concerning Future Improvement of Vidicons for the Pbs Region

This paragraph intends to emphasize the difficulty of estimating future improvement and, of interpreting the predictions, without detailed data. This difficulty can be typified by two quotations as follows:

- 1) "Vidicon for the spectral region from 1 micron to 3 microns can be expected to be available by 1964, with an average noise equivalent power (NEP) of 3×10^{-12} watts in unit bandwidth, per resolution element," of more than 5×10^5 elements. (Secret Data) (Ref. 7.7.1).
- 2) "A most sensitive experimental infrared photoconductive pick-up tube* operating on the vidicon principle with PbTe target (sensitive area) has an NEP of about 7×10^{-11} watts in 30 cps bandwidth, per resolution element of 10^6 elements." (Confidential Data) (Ref. 7.7.2).

Converting this latter NEP value to a one cps bandwidth, one obtains $(7 \times 10^{-11}) / (30)^{1/2} \approx 1.2 \times 10^{-12}$ watts/resolution element. Thus, a direct comparison of

(7.7.1) Passive Radiation Countermeasures Feasibility Studies, AF 04(696)-30. Task II Summary Report, Part I, Hughes Aircraft Company, 12-31-61, (8).

(7.7.2) IRIS, Vol. 5, No. 1 (Secret) p. 409, Confidential.

* Made prior to 1960.

1.2 x 10⁻¹² to 5 x 10⁻¹² would indicate a very conservative prediction of improvement. However, by further converting--on the basis of NEP α (area of resolution element)^{1/2} and, on the basis of identical target areas--the NEP of the future tube to a (5 x 10⁵)/(10⁶) = 50 times larger resolution element, one could compare the early experimental tube with the future tube on a more equal basis:

$$NEP_{exp.} = 1.2 \times 10^{-12} \text{ watts/Hz} = 1 \text{ cps, res. element}$$

$$NEP_{future} = 3.5 \times 10^{-11} \text{ watts/Hz} = 1 \text{ cps, res. element}$$

Assuming now that the experimental tube is the one the prediction has been based upon (or, similar prediction can validly be based upon), one might arrive at the conclusion that high resolution is expected to be very hard to obtain. However, whether this will be correct or false is not known. Comparative predictions concerning the performance of future tubes require evaluation of all the pertinent factors involved.

7.7.3 Summary

A large variety of highly developed single-element detectors are obtainable. Special arrays or mosaics can be constructed.

The availability of IR image tubes, however has not been surveyed to the level needed for high confidence in predictions regarding their future performance. Predictions given in the current literature are of doubtful validity.

7.7.4 Appendix: Illustrative Example of Detector Selection

During the early phases of the study, using the virtual calculation of the "canonical" campfire, radiant power of the campfire was assumed to emerge

~~SECRET~~

from the jungle with a loss factor (because of various attenuating mechanisms) of between 10^{-6} and 10^{-3} . Estimates based on these limits were made at that time and are repeated here as illustrative of the detector selection process even though present thinking makes them somewhat irrelevant. The calculations are for requirements for airborne detection of a point target whose radiant power P_0 , is 10^3 watts/steradian, with a 2400°K blackbody spectral distribution. Line scanners, photographs, and image orthicons were examined.

7.7.6.1 Line-Scanner

Let

- R = slant range from top of the jungle to detector (cm),
- $\beta_{\Delta\lambda}$ = fraction of P_0 in the spectral region of detection $\Delta\lambda$,
- $t_{\Delta\lambda}$ = effective transmittance of atmospheric path in the spectral region $\Delta\lambda$,
- t_j = "transmission" of the jungle.

then the power-density from the target, at the aperture, (P.D.)_g, is

$$(P.D.)_g = \frac{t_{\Delta\lambda} t_j \beta_{\Delta\lambda} P_0}{R^2} \quad (\text{w.cm}^{-2}) \quad (1)$$

when a Lambertian spatial distribution of ($t_j \beta_{\Delta\lambda} P_0$) is assumed.

In addition to the signal, radiation due to natural illumination on the top of the jungle, will also fall on the aperture*. When this

* Because of the spectral region considered here, the thermal radiation of the jungle-top is negligible.

illumination is $I_{\Delta\lambda}$ (w.cm^{-2}) and the diffuse reflectivity of foliage is $\rho_{\Delta\lambda}$, then--in a field of view of Ω steradians--the average power-density from background-radiation, $(P.D.)_B$ is

$$(P.D.)_B = \frac{t_{\Delta\lambda} \cdot \rho_{\Delta\lambda} \cdot I_{\Delta\lambda} \cdot \Omega}{1} \quad (\text{w.cm}^{-2}) \quad (2)$$

As the average "effective reflecting area" varies with field of view, $(P.D.)_B$ will have a modulated component because the background is being scanned. Denoting with m the ratio of the rms modulated component over the average power-density, then the rms background-noise, N_B is

$$N_B = m \cdot (P.D.)_B = \frac{t_{\Delta\lambda} \cdot \rho_{\Delta\lambda} \cdot I_{\Delta\lambda} \cdot m \cdot \Omega}{1} \quad (\text{w}_{\text{rms}} \times \text{cm}^{-2}) \quad (3)$$

From Equation (1) and (3), the signal-to-background noise ratio, $\frac{S}{N_B}$ is

$$\frac{S}{N_B} = \frac{t_{\Delta\lambda} \cdot \beta_{\Delta\lambda} \cdot P_0}{R^2 \cdot \rho_{\Delta\lambda} \cdot I_{\Delta\lambda} \cdot m \cdot \Omega} \quad (4)$$

The maximum value m can take is 0.7 when "fully reflecting areas" subtended by the field of view and areas "not reflecting at all," are considered alternately scanned so that a sinusoidal time-variation of the power-density results. (A minimum value of m we could consider here, is perhaps not much less than 0.05 which would prevail if the average reflecting area subtended by the field of view varied by the peak amount of $\pm 70\%$.)

The spectrally dependent quantities in Equation (4) are β, ρ and I and, the choice of spectral-region of detection should obviously be

~~SECRET~~

governed by the quantity of $\frac{\rho_{\Delta\lambda} \cdot I_{\Delta\lambda}}{\rho_{\Delta\lambda} \cdot I_{\Delta\lambda}}$. Because of detector limitations only three spectral regions are reasonable. These are shown below, together with the spectrally dependent quantities:

$\Delta\lambda$	0.4 μ - 0.7 μ	0.7 μ - 1.1 μ	0.9 μ - 2.5 μ
ρ	0.02	0.14	0.64
$\frac{I_{\Delta\lambda}}{I_{0.4 - 0.7}} = X$	1.00	0.58	0.76
ρ	0.20	0.35	0.10
$\frac{\rho}{\rho} = 1$	0.10	0.69	8.4
$\frac{Y_{\Delta\lambda}}{Y_{0.4 - 0.7}}$	1.00	6.9	8.4

In calculating the values of $I_{\Delta\lambda}$, a 6000°K black-body spectral distribution was assumed. Furthermore, the values of ρ are "typical" values based on the diffuse reflectance of tulip leaves at "the wavelengths of maximum energy", (Ref. 7.7.2) (sic) follows: 0.22 at 0.6 μ , 0.38 at 0.95 μ and, 0.056 at 4.4 μ . Consequently, the effective value of $\rho = 0.35$ in the region between 0.7 and 1.1 microns is perhaps the most realistic; in contrast, the values for the two other regions might be in error by $\pm 50\%$ or more. Of course, differences between the reflectance of tulip leaves and average jungle-
foliage are not known. To be conservative, since the validity of these assumptions is questionable, the entire area subtended by the field of view, is taken

(7.7.2) Handbook of Chemistry and Physics.

~~SECRET~~
7.143

SECRET

SECRET

to be reflecting, although only a fraction of the area is expected to be reflecting.

At a slant range of $R = 1$ km and with $I_{0.4 - 0.7} = 10^{-7}$ w.cm⁻² (half moon 40° above horizon), $\tau_j = 10^{-6}$ and $m = 0.35$, we get, from Equation (4) the following values of Ω :

	$\frac{S}{N_j} = 4.25$	$\frac{S}{N_B} = 8.5$
$\Omega_{0.4 - 0.7} =$	1.8×10^{-6}	0.9×10^{-6}
$\Omega_{0.7 - 1.1} =$	2.32×10^{-5}	1.16×10^{-5}
$\Omega_{0.9 - 2.5} =$	2.8×10^{-4}	1.4×10^{-4}

With these in hand the characteristics of the detection-equipment can be defined:

With an effective aperture area of $A_A = \frac{D^2 \pi}{4}$ cm² (D = diameter), and with a semiconductor detector of area A_D cm², the following identity must be fulfilled when a signal to detector noise ratio of $\frac{S}{N_D}$ is required: $\frac{D^2 \pi}{4} \cdot (P.D.)_S = (NEP) \cdot \frac{S}{N_D}$. From here, with Equation (1), and with

$$NEP = \frac{A_D^{1/2} (\Delta t)^{1/2}}{D^2} = \frac{A_D^{1/2}}{D^2} \left(\frac{V\sigma}{Hz} \right)^{1/2}$$

we get:

$$D^2 = \frac{4 R^2 A_D^{1/2}}{c \Delta \lambda^2 j_{\Delta \lambda} P D^2} \cdot \left(\frac{V\sigma}{Hz} \right)^{1/2} \cdot \left(\frac{S}{N_D} \right) \quad (5)$$

SECRET

SECRET

~~SECRET~~

V = ground speed of aircraft in km/sec

H = flight-altitude in km, and

σ = total scan-angle in radians.

The square of the required focal length, f is

$$f^2 = \sigma^{-1} \times A_D \quad (6)$$

From Equations (5) and (6)

$$A_D^{1/2} \left(\frac{D}{f}\right)^2 = \frac{4 R^2 f^{1/2}}{t_A t_j^2 P_o D^*} \cdot \left(\frac{V\sigma}{H}\right)^{1/2} \cdot \left(\frac{S}{N_D}\right) \quad (7)$$

and with values of

$$V = 120 \text{ km/hr} = 3.34 \times 10^{-2} \text{ km/sec}$$

$$H = 0.58 \text{ km}$$

$$\sigma = 2 \text{ radians}$$

$$\sigma^{1/2} = 4 \times 10^{-3} \text{ rad.}, \frac{S}{N_D} = 8.5 \text{ and, with Si detector } (D^* = 2 \times 10^{13}; A^{1/2} \left(\frac{D}{f}\right)^2 =$$

$$5.8 \times 10^{-2} \text{ cm in an } F/1.25 \text{ system } (D = 0.8f).$$

One then obtains

$$A_D^{1/2} \left(\frac{D}{f}\right)^2 = 0.9 \times 10^{-1} \text{ cm } (0.9 \text{ cm})$$

and

$$f = 18.0 \text{ cm, } D = 14.4 \text{ cm } (5.7 \text{ inches})$$

$$\text{or } \begin{cases} A_D^{1/2} = 0.5 \times 10^{-1} \text{ cm} \\ f = 10 \text{ cm, } D = 11.6 \text{ cm} \end{cases}$$

Using PbS detector for the spectral region between 0.9 and

2.5 microns ($D^* = 3 \times 10^{10}$, $\beta = 0.64$) $A^{1/2} \left(\frac{D}{f}\right) \approx 14 \times 5.8 \times 10^{-2} \text{ cm} = 0.81 \text{ cm}$.

Thus, even if a detector as small as 0.1 mm x 0.1 mm is assumed, the required $\left(\frac{D}{f}\right)^2$ is $\left(\frac{D}{f}\right)^2 = 0.14 \times 5.8 \times 10^{-2} \approx 81$. Or,

$\frac{D}{f} = 9$, which constitutes a non-feasible system! Conversely, however, an F/1 system would require 0.81 cm square detector and $f = 162 \text{ cm}$ which is an impracticable size. When the PbS detector is cooled to the temperature of dry-ice, $D^* = 2 \times 10^{11}$ and,

$$A^{1/2} \left(\frac{D}{f}\right)^2 = 2.2 \times 5.8 \times 10^{-2} \text{ cm} = 1.27 \times 10^{-1} \text{ cm}$$

Thus, a 0.5 mm x 0.5 mm detector required $\left(\frac{D}{f}\right)^2 = 2.2 \times 5.8 \times 0.5 \times 10^{-1} \times 10^{-3} = 63.8 \times 10^{-2}$ or $\frac{D}{f} = 0.8$: $f = 10 \text{ cm}$ and $D = 8 \text{ cm}$ or, 1.7 mm x 1.7 mm detector could be used in an $f = 10 \text{ cm}$, F/0.86 system.

Consequently, a successful detection can be expected of practical size equipment using Si or cooled PbS detectors.

7.7.4.2 For photographic detection, we should require that the density of the film caused by the radiation from the fire, be n-times the fog-level of the most dense portion of the background. So, at a fog level density of D_f , the following identity must be fulfilled:

$$nD_f = \log \frac{I_b}{T_b}$$

Here T_b = transmission of film occupied by target.

T_b = transmission of film occupied by the brightest element of the background.

SECRET

7.166

But, $\log \frac{1}{I_s} = \gamma \log E_s$ and, $\log \frac{1}{I_B} = \gamma \log E_B$, where E = exposure of the film and, $\gamma = \frac{dD}{u \log 2}$. Consequently, $\log \frac{I_B}{I_s} = \gamma \log \frac{E_B}{E_s}$ and, $\log \frac{E_B}{E_s} = n \frac{D_F}{\gamma}$. (1)

In order to evaluate Equation (1), we must know the power-density of the target's image and of the brightest background-element's image. We can determine this as follows:

If the target subtends, at the aperture, the solid angle ω_T and the background-element subtends ω_B , then the image size of the target is $f^2 \omega_T$ and the image size of the background element is $f^2 \omega_B$ when f is the focal length of the optics.

When the target radiates P_s watts/sterad, then the power-density from the target at the aperture, (P.D.)_s, is

$$(P.D.)_s = \frac{P_s}{R^2} \text{ (w.cm}^{-2}\text{) and,}$$

the power-density in the image of the target, E'_s is

$$E'_s = \left(\frac{f}{D}\right)^2 \frac{\pi P_s}{4R^2 \cdot f^2 \omega_T} = \frac{\pi P_s}{f^2 \cdot 4R^2 \omega_T} \text{ (w/cm}^2\text{)} \quad (2)$$

There, $F = \frac{f}{D}$ (focal ratio of optics) with D = effective aperture diameter in cm.

Similarly, the power-density in the image of the background-element, E'_B is

$$E'_B = I_B \frac{\pi}{f^2 \omega_B} \text{ (w/cm}^2\text{)} \quad (3)$$

where I_B is the radiance of the background-element in $\text{w.cm}^{-2} \text{ sterad}^{-1}$.

Consequently,

$$\frac{E_s}{E_B} = \frac{P_s}{T \times I_B} = \frac{P_s}{I_B \omega_T R^2} \quad (4)$$

Assuming that $\omega_T = 10^{-6}$ sterad. ($1m^2$ subtended area at a range of 1 km) and, with the previously used values of $c_j = 10^{-4}$, $I_{0.4} = 0.7 = 10^{-7} \text{ w.cm}^{-2}$, $\sigma = 0.22$ and $\beta = 2 \times 10^{-2}$, we get $\frac{E_s}{E_B} = 4.5$.

Thus, from Equation (1), $n = 5$, when the film is developed to a $\gamma = 0.7$ and $D_F = 0.15$. Using a film with a speed of ASA = 400, the required exposure to reach the linear portion of the density vs. log exposure curve at $\gamma = 0.7$, is $\frac{40}{400} = 10^{-1}$ meter-candle-second = 1.47×10^{-8} watt sec cm^{-2} . Consequently, from Equation (2) the required exposure-time, T is

$$T = 1.67 \times 10^{-8} \frac{4F^2 R^2 \omega_T}{\pi P_s} F^2 \text{ seconds} = 5.9 \times F^2 \times 10^{-2} \text{ seconds.}$$

In order to fully define the optical system first the image-size has to be specified. When this is set to equal 100 resolution-elements and the resolution is 50 line pairs per mm, the image-size of the target, $f^2 \omega_T \approx 10^4 \text{ cm}^2$. Then with $\omega_T = 10^{-6}$, $f = 10 \text{ cm}$.

At an effective aperture diameter of 5 cm, $F = 2$ and the exposure time $T = 0.24 \text{ sec}$.

At a field of view of 45° square, and, at an aircraft-velocity of 200 km/hr, 100 km^2 can be surveyed in one hour. The required image-motion-compensation is about 5 mm/sec.

~~SECRET~~

With infrared film, the exposure-time T_{IR} is

$$T_{IR} = \frac{S_{0.4-0.7} \cdot \beta_{IR}}{S_{IR} \cdot \beta_{0.4-0.7}}$$

where S_{IR} = ASA speed of IR film $\approx 0.05 \times S_{0.4-0.7}$. Thus, $T_{IR} > T_{0.4-0.7}$ could be expected. (We do not give here a numerical value for T_{IR} because β_{IR} has not been determined).

7.7.4.3 With an Image Orthicon, an image-illumination of 6×10^{-8} w/cm^{-2} can be read out with a signal-to-noise ratio of about 26 when the pre-amplifier's noise is 2×10^{-9} ampere in a 5 MC bandwidth [see "Survey and Evaluation of Phenomena and Techniques in the Ultraviolet, Visible and Sub-millimeter Region for Application to Detection and Astrosurveillance" Geophysics Corporation of America, Bedford, Mass. AF 19(604)-7412. Final Report Part I, p. 276. Unclassified, 1 July 1961].

As was previously found, this level of illumination would prevail in an F/2 system. Consequently, a signal to noise ratio of 10 can be had in an F/3.5 system, a high enough value to permit the readout of a single resolution-element. However, the 45° square field of view specified for photographic detection, must be decreased by a factor of $10^6 \times (2 \times 10^5)^{-1} = 5$ assuming that the image orthicon has 2×10^5 resolution elements. (For photographic detection, 10^5 resolution elements and a target-image of 100 resolution elements were specified.) Thus, image orthicon permits, in 1/60 sec (real time) the surveillance of one fifth of the area that it is possible to record by the photographic method with 1/4 of a second exposure-time.

~~SECRET~~
7.149

~~SECRET~~

Realization of higher orthicon surveillance rates, however, would require the simultaneous use of, for instance, two cameras to cover 36° lateral field and, an increase of the flight-speed by a factor of about 4.4. A distinct advantage of the image orthicon is that it allows a readout in real time. Moreover, there may be some advantage in that personnel around the campfire would, perhaps, be less concerned over passage of high speed aircraft.

On the basis of such initial estimates it was concluded that a good possibility seemed to exist of detecting the radiant power from 2400°K campfires at wavelengths less than about 2 microns at night when the natural illumination was not more than that from a half moon at high elevation. Any of four equipments;

Television camera with Image orthicon;

Photographic camera with panchromatic film;

Line-scanner with Si detector; or

Line-scanner with cooled PbS detector;

might be employed.

~~SECRET~~

SECTION 8

RADAR

Only a modest amount of effort has been devoted to radar applications in this study. This happened for two reasons: first, ARPA planned a full demonstration of the capabilities of service equipment, to be followed by a symposium, with subsequent program planning; second, many proposals from industry were expected and it was planned to critique these in the study. The field demonstration was set up several times but never actually came off. Only one proposal (PASS) was forwarded for comment. Whether others were received is not known.

In this Section some comments are given on anti-personnel radars. A critique of the PASS proposal and a suggested experimental program is outlined (8.1). A suggested approach to the use of radar against ambushes, and comments on mapping with radar, are given in (8.2).

CONTENTS

- 8.1 Personnel Detection
 - 8.1.1 Service Equipment
 - 8.1.2 PASS Proposal
 - 8.1.3 Critique and Suggested Program
- 8.2 Other Applications
 - 8.2.1 Anti-Ambush Radar
 - 8.2.1.1 General
 - 8.2.1.2 Conventional MTI Problems
 - 8.2.1.3 Pulse-Modulated Doppler Techniques

~~SECRET~~

~~SECRET~~

~~SECRET~~

CONTENTS (Continued)

8.2.1.4 Radar Parameters

8.2.1.5 Summary

c.2.2 Radar Mapping

8.3 Summary

8.1. Personnel Detection

8.1.1. Service Equipment

Current military combat surveillance radar through 1959 are discussed in a special DDR&E memorandum (ref. 8.1) of chief interest is the AN/FPS-4 (Silent Sentry) anti-personnel radar whose characteristics are given in Table 8.1.1 below:

TABLE 8.1.1 Characteristics of AN/FPS-4

Lightweight, portable pulse doppler (Silent Sentry)	
Range	Personnel-1500m. vehicles-5000m.
Acc.	25m x 3°
D	8900-9400 mi.
\bar{p}	1 watt
P	1 kW
PRF	5000
MFI	non-coherent
Scan Rate	man. in range hzi & elev.
Elev.	900 to 600 miles
Asi.	360°
B Width	6.5° x 6.5°
Ant.	17 5"
Characteristics	
Wgt	1150
Transport	Manpack 2 men
Primary Power	125 watts

8.1 Weinstein, A. et al (U) EDT&E Electronic Programs Concerned with Combat Surveillance 17 March 1960
DDR&E Memorandum (Electronics) Sec.

~~SECRET~~

~~SECRET~~

A "Handheld" anti-personnel radar is being developed at Evans Signal Laboratory (contacts: Harold Tate; Victor L. Fredericks).

The AN/PFS-4 is being tested in the Far East. The first test (ref. 3.1) was unsatisfactory, resulting in no personnel detection. The results of subsequent testing are not known to the Contractor.

Since a light-portable radar would be useful for protection of patrols, and in setting ambushes it is suggested that if, as is fairly likely, current T. O. & E. equipments are not satisfactory for one reason or another, considerable effort be expended to design and procure satisfactory equipment.

The AN/MPS-29 radar (ref. 8.2) is an experimental, vehicular transported, ground surveillance radar designed for high-resolution visual display of ground targets at short ranges. There is an operation van, antenna trailer and power unit trailer but this is because no attempt was made to reduce size and weight given in Table 8.1.2 below:

Table 8.1.2 Characteristics AN/MPS-29

Electrical Characteristics

Frequency	70 Kmc
Pulse Length	0.05 microsecond
Peak power	15 Kw
Pulse repetition frequency	9,990 cps
Wave length	4.3 mm
208 volts, three-phase 100 cycles/sec	12 Kv-a
28 volts, DC	Max load 0.5 Kw

8.2 (U) Evaluation of Concepts and Techniques of AN/MPS-29
U.S. Army Infantry Board, Ft. Benning June 1961 (Conf.)
(AD 324 432L)

-83-

Table 8.1.2 Characteristics AN/MPS-29 (Continued)

Resolution Characteristics

Azimuth beam width	0.2° (3.5 mile)
Elevation beam width	0.3° (5.3 mile)
Scan rate	20/scans/second normal 40/scans/sec capability
Scan sector	30° (150 beam width) or 534 mile

Sensitivity Characteristics

Antenna gain (including losses)	54.7 db
Antenna losses	2.9 db max
Wave guide losses	0.4 db
TR-ATR (BL-24)	4.6 db max (2-way)
Transmitter (BL-221)	0.5 kw
Receiver noise figure (Philco 18 db L-5506 crystals & 4 db IF N.F., QK-369 Klystron)	

Other Characteristics

Elevation angle \pm mile from horizontal

In the tests stationary targets could only be detected in the searchlight mode. Moving targets were located and identified reliably at the following ranges:

<u>Target</u>	<u>Range (Meters)</u>	
	<u>Maximum</u>	<u>Minimum</u>
Truck, 1/4 ton	6200	50
Squad, moving	2000	50
One man, running	1200	50
One man, walking	1000	50
One man, crawling	Undetected	

~~SECRET~~

The fire from flat trajectory and high angle fire weapons, excluding small arms, was sensed satisfactorily to 4200 meters.

While this performance looks good, there were a number of difficulties with display interpretation and in area coverage tests personnel were not detected satisfactorily.

8.1.2. PASS Proposal

On 14 December 1961, Conduction and Automatic Corporations made a joint proposal to ARPA for a Partisan Airborne Surveillance System*. (ref. 8.2) The systems operation was to be "based on a specialized fine resolution coherent radar with airborne signal correlation to produce extractable signals from groups of men carrying moderate pieces of equipment in dense jungle."

On the basis of a simplified model of rainforest as a complex scatterer and absorber, and on the approximate cross-section of a man carrying a rifle, the appropriate wavelength of the radar was determined to be about 1 meter, and power, aperture, and sensitivity requirements were defined, leading to a preliminary design of the system.

A proposed accelerated development schedule envisaged system integration propagation experiments, equipment design, assembly component tests, aircraft modifications, installation, and flight tests carried on concurrently in the first twelve months in an essentially "build-it-and-try-it" program. Operational tests, on this schedule, would have begun in the fourteenth month and have been concluded in the eighteenth month.

*With proposers' permission this proposal was forwarded to DRC for evaluation.

~~SECRET~~

8.1.3. Critique and Suggested Program

At ARPA's request the proposal was critique-ed by DRC. A meeting was held at ARPA on May 7, with Conductron to discuss the proposal and a suggested alternative program.

It was evident that the success of the proposed project depended on resolution of many factors which were not well known. Whereas the proposal, in the interest of a most expeditious approach planned to build an equipment and flight test it as rapidly as possible, the suggested program was first to resolve the major uncertainties by fairly simple experiments and then to proceed with developing new equipment if experimental results justified this step. This program was agreed to by ARPA and Conductron. As of this date the program has not yet been funded and it is not known whether a report on target and environmental conditions in the Far East has been prepared as an input to the program.

Some of the major uncertainties in the PASS Proposal are listed below:

1. Attenuation of 1 meter wavelength radiation due to jungle growth is assumed to be comparable to that due to woods found in the northeastern U. S. Since jungle growth is generally more dense and contains more moisture this is questionable.
2. Only tree trunks are assumed to be large background targets. Leaves and branches are assumed to be Rayleigh scatterer and, hence, not important. Many branches of trees should be expected to be comparable to the 1 meter wavelength in size, and therefore, significant.

~~SECRET~~

- SECRET
3. Trees are assumed to be confined to single resolution elements (3 X 3 meters). Because the trees, as seen by the radar, are extended in range, and because there is multiple scatter (particularly with the ground) the effects of a large tree can be observed in a large number of resolution elements.
 4. Accuracy with which aircraft velocity must be known is said to be 2 meters/sec. During the establishment of the aperture, the ground can "move" 20 meters with respect to its assumed location. [The effect of this could not be explained by the Condustron people at the May 7 meeting.]
 5. The problem of detecting moving targets was not satisfactorily covered. Walking men can be expected to move through a few resolution cells during observation.
 6. The problem of clutter motion between looks (wind, etc.) and the effect of multiple scattering on the results when flight paths are not repeated precisely is not covered adequately.

Many other points in the PASS proposal could be argued, but these depend so much on factors basically unknown that the arguments would be academic. For example, while one might take exception to false alarm and detection probabilities assumed to be useful for gaining information, the great uncertainty as to the achievability of any useful combination of false alarm and detection probabilities would render any argument sterile. Any detailed concern about map matching, etc., seems premature.

The suggested initial program involved:

- c. An experiment wherein attenuation of transmission from an elevated platform (tower or cliff) to a receiver on the ground in the jungle is measured. A reasonably large elevation angle ($\sim 15^\circ$) would be desirable to avoid having to penetrate too much jungle.
- b. Comparable measurements with other types of vegetation.
- c. Measurements of jungle components (trees, branches, etc.) on existing ranges, if feasible.
- d. Using results of a, b, and c, to estimate the magnitude of the multiple scattering problem.
- e. Study of spatial and temporal clutter variations.
- f. Data collection on the nature of the target, what he carries, how he moves, etc.
- g. Construction of representative models of the target and background and measurement of radar observations of target and background separately and together.

It was also suggested that, since guerillas were to be found in many environments other than dense jungle,

- b. Existing side-looking equipment should be employed, concurrently with above program against suitable targets in less troublesome and well-known environments, with progressive increases in difficulty of the detection problem until existing equipments failed to perform.

Finally, depending on the outcome of the activities described, it was suggested that,

- i. A study should be made to determine if there is a detection and processing technique which is optional for dealing with the target and clutter models developed.
- j. If the answer to i.) was affirmative, then, depending on the situation at the time and the cost of system development, a development program should be started.

8.2. Other Applications

Considering some of the situations described in 2.3., it seems reasonable to inquire whether radar can be useful in ambush situations, in outpost protection, against ground-fire at helicopters and airplanes, and in detecting trails and corridors (bands of lower ground-cover density) under dense canopy. The first three possibilities are discussed under the general heading of anti-ambush radar (8.2.1) and the latter under the heading of radar mapping (8.2.2).

8.2.1. Anti-ambush Radar

8.2.1.1. General

The basic notion is to make available combined radar and fire-directing equipment which would fulfill the tactical requirement (to fire back quickly and accurately when ambushed) discussed in Section 2. This is particularly suggested for road convoys and helicopters, and possibly for low-flying airplanes and even for trains. It is probably only applicable to such conditions when there is some open space between the ambushed group and the source of fire. The problem has been treated in terms of rifle fire, which includes the less difficult case of automatic weapons fire and some

discussion of mortar tracking⁴ has also been given. No attention has been given to the design of the fire-directing equipment nor to detailed problems of design of equipment for airborne use.

The major advantage of using radar in a situation of ambush is the speed and accuracy with which the source of fire can be located. Volume can be scanned many times faster than by eye, for example, and the radar detects the bullet which is always present rather than the smoke or flash or the actual gun, each of which can deliberately be made difficult to detect. The radar is also capable of ranging accuracies much greater than the unaided eye and comparable with that of range finders. [The radar additionally could detect the counterfire and thus serve as a substitute for a spotter in some situations, for those weapons not controlled by the radar.]

8.2.1.2. Problems of Conventional MTI

If the bullet as an isolated target were all that the radar had to worry about, the problem would be relatively easy, as may be seen from some simple calculations. As an example, consider an X-band radar ($\lambda = 3.2$ cm) with a 3 ft. diameter dish antenna for detecting a .30 cal. bullet at a range of one half nautical mile. If the bullet is approximated by a 0.30" diameter sphere, then the ratio of radius to wavelength (a/λ) is about 0.1 and for $a/\lambda \geq 0.1$ a radar cross-section approximately equal to the projected area, or about 0.00049 sq. ft. may be assumed. The antenna has an area of 7.1 sq. ft., and at 60% aperture efficiency the effective area is 4.25 sq. ft., with a gain at $\lambda = 3.2$ cm of 3370. The attenuation between transmitter and target is therefore;

⁴Mortar locators have been in existence a long time and current models may be satisfactory. (Sperry MPQ-10-[1952])

~~SECRET~~ ~~SECRET~~

$$\frac{P_R}{P_T} = \frac{GA\sigma}{(4\pi)^2 R^4} = 0.548 \times 10^{-15} \text{ or } -152.6 \text{ db}$$

A conventional search radar, using 1.0 microsecond pulses, requires a received signal of about 123 db below 1 watt to detect a target; thus, the assumed radar needs only 1 kilowatt peak pulse to detect the bullet at 1/2 mile range. Increasing the range would, of course, increase the peak power requirements in accordance with R^4 , but increasing the pulse length or increasing the target cross-section (e.g., considering 20 mm cannon projectiles) will reduce the requirements. Obviously, if radar receiver noise were the only problem, radar requirements for detecting a bullet are not excessive.

Unfortunately, in the ambush situation, the source of the bullet is concealed, if at all possible, using all available terrain features. Rather than competing against receiver noise, the radar return from the bullet is completely masked by echoes from the surrounding terrain, which may be 60-100 db* above the echo strength of the bullet. Conventional MTI techniques, which may provide up to 40 db sub-clutter visibility, just don't provide enough performance to do the job.

3.2.1.3. Pulse-modulated Doppler Techniques

During the early 1940's quite an effort was expended analyzing and investigating C-W radar techniques. In spite of the obvious advantages of ease of discrimination between moving and fixed targets and the capability of direct velocity measurement, the C-W radar suffered from an inability to determine range or to handle multiple target simultaneously

*See, for example, Ridenour, "Radar System Engineering", Vol. I, MIT Radiation Lab Series, McGraw-Hill, p.154.

~~SECRET~~ ~~SECRET~~

~~SECRET~~

without difficulty. Several modulation techniques were investigated to combat these difficulties, and one of the most successful was the use of on-off keying.²² The technique was described as pulse-modulation of a Doppler system, rather than a system of processing Doppler information from a pulse system. Fundamentally, the method trades the ease of target resolution of a pulse MTI system for the opportunity to design filters which suppress undesired ground clutter in a near optimum fashion.

The one model of a pulse-modulated Doppler system brought to a product stage demonstrated a reduction of ground clutter in excess of 95 db. Operating with a single target it was able to determine range to about 1% of maximum, but it generated a confused display when there was more than one target in the beam simultaneously. It suffered, too, from the 1940 state-of-the-art with respect to crystal controlled microwave sources. Since there were very few situations in 1945 where the MTI systems did not prove satisfactory (an aircraft in extreme mountainous terrain was the outstanding exception) and since range resolution became increasingly important in aircraft detection and tracking, the pulse Doppler systems were not pursued.

The bullet from ambush, however, presents a situation quite analogous to that for which the pulse Doppler showed outstanding capability. Usually, there will be one to, at most, a few targets present simultaneously in the antenna beam, but the ratio of clutter to target signal strength will be extremely high. The state-of-the-art regarding techniques for generating crystal-controlled microwave power has come of age with the advent of transistors, varactor multipliers and traveling

²² op. cit., pp 150 et seq.

~~SECRET~~

████████████████████

████████████████████

wave amplifiers. Thus, it appears that serious consideration should be given to possible application of these techniques.

A bullet traveling at 2500 ft/sec will generate a doppler frequency of 40 kilocycles when the carrier frequency is 9400 mc ($\lambda = 3.2$ cm). At this carrier frequency the repetition rate should preferably be placed above the doppler frequency to eliminate velocity dead zones, at perhaps 50-60 kc to produce an unambiguous range of $\pm 1.6 - 1.3$ miles. Any higher carrier would result in either too short an unambiguous range or would have a velocity dead zone that might be troublesome. On the other hand, if a lower carrier frequency were chosen the a/λ for a rifle bullet would lie below 0.1 and in the region of Rayleigh scattering where the radar cross-section becomes much smaller than the projected area. The decreased carrier would, therefore, increase the power requirements as well as increasing the antenna area required for a given antenna gain. Thus, the initial estimate of X-band utility appears justified. It may be noted in passing that a very high antenna scan rate may be employed with the selected high repetition rate without unduly increasing the scanning noise. Preliminary calculations indicate that scan rates as high as several hundred degrees per second can be employed without unduly complicating the problem of rejecting ground clutter while still passing the moving target.

The requirement for crystal controlled microwave power at X-band can be met with a combination of solid state amplifiers and multipliers, with a traveling wave tube or klystron for a final amplifier. For example, a 5.8 mc crystal controlled transistor oscillator can be

~~SECRET~~

followed by three triplers and a power amplifier to provide 10 watts at 156.6 mc. This power drives a chain of varactor multipliers consisting of a tripler, two doublers, and a quintupler which generate successively 3 watts at 470 mc., 1 watt at 940 mc., 0.3 watts at 1880 mc., and 30 mw at 9400 mc. The power output from the multiplier chain is sufficient to drive a traveling wave of klystron tube which will produce the 3 kw final power output.

A long persistence FPI, possibly incorporating a storage tube for longer persistence is suggested for visual display and possible manual override of the fire director. In operation, either the entire azimuth or the suspected azimuth sector could be examined by the radar. Although on any particular scan only a portion of the trajectory of a bullet might be observed, the observation of several successive trajectories could establish the maximum range at which a bullet was observed and the azimuth at which this range occurred, thus indicating the location of the origin of fire.

Another feature that would probably be of great utility in this radar is "Monopulse Resolution Improvement", wherein a monopulse (simultaneous lobe comparison) antenna feed and circuitry are arranged so that, on the display, an echo is displaced in azimuth by an amount equal to the measured azimuth error at the time the echo is received. Although of limited usefulness in a situation where many targets are present, the MRI feature here should provide a crisper, sharper display which allows the target azimuth to be measured more quickly and accurately.

8.2.1.4. Radar Parameters

To summarize, then, a tentative set of radar parameters is as follows:

Frequency	9400 mc
Peak Power Output	3 kw
Repetition rate	50 kc
Pulse length	2 μ sec
Duty cycle	0.1
Average power	300 watts
Antenna diameter	3 feet
Antenna gain	3370
Antenna beamwidth	2.4 deg.
Azimuth scan rate	360 deg/sec (or 1 rev/4sec)
Maximum displayed range	8500 feet
Range accuracy	20 feet
Azimuth accuracy	0.3 deg
Range performance (30 cal)	4000 feet
Sub-clutter visibility	90 db

The above radar was designed specifically against .30 cal rifle fire. It is obvious that the same radar will detect fire from larger arms (e.g., 20 mm cannon to 6500 ft., or 75 mm recoilless rifle to 12,500 ft. if the repetition rate is changed,) but that it would probably not work too well against mortar fire because of the low radial velocity at launch and the lofted trajectories flown. However, the range performance

of the radar is certainly ample for detecting the mortar shell in flight, and the possibility of an additional operational mode should be seriously considered.

The same radar could be constructed to detect mortar fire by providing complete tracking capability for the antenna. If necessary, the doppler feature could be switched off, or at least modified to allow lower velocity targets to be detected. The antenna beam could be elevated to reduce the ground clutter, and then set to search rapidly in azimuth until a mortar shell is detected. The beam would then be pointed at the correct azimuth, and arranged to track automatically the next shell that passed through the beam. From the trajectory as determined by the track, the point of origin of the shell could then be located.

8.2.1.5. Summary

The preceding preliminary analysis has served to indicate an area of radar art that could prove highly useful in certain specialized combat situations. However, additional analysis is required to demonstrate the value of the suggested approach. The preliminary system characteristics outlined above, for example, provide a blind speed of about 3100 ft/sec and a blind range of 9600 ft.

Either of these may be raised and the other lowered by changing the repetition rate, but to raise both will require lowering the carrier frequency and sacrificing radar performance on bullets .30 cal and smaller. Yet when it is considered that 150 gr. .30 cal bullets are sometimes fired with muzzle velocities as high as 3500 ft/sec, and that the 57 mm and 75 mm recoilless rifles are effective at ranges up to 2 miles,

it is obvious that at least some changes in the preliminary specifications should be considered. It is important, therefore, that the entire spectrum of expected noise be examined thoroughly in order that the compromises in performance are thoroughly understood. However, it is expected that reasonable compromises can be obtained upon detailed examination of the problem.

Derivative data must be obtained regarding the magnitude of clutter expected under the anticipated operating conditions, and the magnitude and frequency of the scanning noise expected under the conditions of high repetition rate and high speed scanning. Although the calculations indicate that this should be no problem, experimental confirmation is required.

It is possible that similar techniques to those discussed above could be applied to the problem of locating the sources of fire from an aircraft or helicopter. Here again, the use of pulse doppler with its long duty cycle, and the great difference of doppler frequency between the bullet to be detected and the background clutter may allow the design of circuitry to provide the necessary sub-clutter visibility. The use of the moving platform for mounting the radar suggests, however, that non-coherent rather than coherent detection techniques be considered. However, from a helicopter even these might not be necessary. Before a final decision can be made, experimental data should be obtained. Perhaps the best approach to determine the ultimate applicability of radar to the combat situations under discussion is the construction of a bread-board set along the lines indicated here wherein the characteristics of

~~SECRET~~

the clutter rejection filters can be varied, the system can be operated either coherently or non-coherently, and the equipment constructed small enough and light enough to be carried aboard an airplane or helicopter during a portion of the test program. A flight test program can be designed both to obtain fundamental data which can be used in final equipment design and to demonstrate feasibility of the basic concepts.

To summarize, the high velocity of a bullet or shell provides an excellent opportunity to use the doppler frequency in distinguishing between the small echo of the desired target and the much larger echo of the undesired background. By employing a large duty cycle (0.1 or greater) and sacrificing the ability of resolving closely spaced targets and of processing and displaying many simultaneous targets, it is possible to overcome the sub-clutter visibility limitations of conventional MTI circuitry. The use of the pulse doppler techniques almost certainly offer a practical possibility for employment as a ground-based radar system in the combat situations under discussion, and have a possible airborne application as well, which bear further investigation.

8.7.2. Radar Mapping

As indicated in Section 2 and discussed in Section 7, a reasonable requirement for detection of anti-guerrilla operations would be for aerial location of trails^{*} under canopy, or density measurements from which could be deduced those regions (bands or corridors) characterized by the lowest density of vegetation (and hence, presumably, the easiest routes for travel).

*"Trails" covers such large trails as the Ho Chi Minh.

SECRET

Considerable attention has been devoted to terrain return in the last few years. (ref. 8.5 - 8.9) providing useful references in addition to the classic work reported in Vol. 13 of the Radiation Laboratory Series (ref. 8.10). Unfortunately, none of these sources are particularly helpful in deciding whether trails, for example, can be detected under dense cover. In ref. 8.8, pages 12 - 13, Burdich suggests that multifrequency scanning should permit evaluation of the depth of layers and the ratios of electromagnetic constraints of the various layers.

Experiments of the type necessary for evaluating the PASS program would be useful here. Certainly it will be necessary to have frequencies which penetrate to various depths in the forest and perhaps to the floor.

It is suggested that some attention be given to this problem and, if possible, the PASS experiments be extended with this possible application in view.

- 8.5 Grant, C. R. Backscattering from Water and Land at Centimeter and Millimeter Wavelengths Proc. IRE July 1957
- 8.6 Cosgriff, R. L. et al Electromagnetic Reflection Properties of Natural Surfaces with Applications to the Design of Radars and Other Sensors Ohio State U. Res. Foundation 1 Feb 1959 (AD 216 418)
- 8.7 Spetner, L. & Katz, I. Two Statistical Models for Radar Terrain Return IRE Transactions on Antennas and Propagation May 1960
- 8.8 U. of New Mexico Radar Return Symposium 11-12 May 1959 NOTIS TP 2338 (AD 244 937)
- 8.9 Edison, A. et al Radar Terrain Return Measured at Near-Vertical Incidence IRE Transactions on Antennas and Propagation May 1960
- 8.10 Kerr Propagation of Short Radio Waves Rad. Lab. Series V. 13 May 1960

~~SECRET~~

6.3. Summary

The problem of aerial surveillance of jungle (and other) areas to detect men carrying rifles, as suggested in PASS, has been examined and a fundamental program of investigation of crucial points suggested.

Application of pulse-modulated doppler methods to various types of anti-ambush radar has been examined and tentative specifications outlined for required performance. The approach seems feasible and it is suggested that the subject be investigated further.

It is also suggested that the PASS experiments be set up to obtain, in addition, the data necessary to answer questions of the feasibility of radar mapping for trails and corridors.

~~SECRET~~

SECTION 9

ACOUSTICS AND GEOPHYSICS

This section deals with acoustics and general geophysical methods of possible interest for anti-guerrilla application. A partial survey is presented of relevant data and factors bearing on the use of acoustic detection devices in heavy vegetation and some particular devices are analyzed. A short discussion of applications is given.

Pertinent geophysical prospecting methods and equipment are reviewed in cursory fashion and some simple calculations relating to the potential utility of magnetometers are given.

CONTENTS

- 9.1. Acoustics Summary
 - 9.1.1. Introduction and Summary
 - 9.1.2. Hearing
 - 9.1.2.1. Loudness
 - 9.1.2.2. Differential Sensitivity
 - 9.1.2.3. Masking
 - 9.1.2.4. Speech
 - 9.1.3. Sound
 - 9.1.3.1. Attenuation
 - 9.1.3.2. Divergence
 - 9.1.3.3. Absorption
 - 9.1.4. Listening Distances in Jungle
 - 9.1.5. Devices

9.1.5.1. Parabolic Reflectors

9.1.5.2. Obstacle Array Lenses

9.1.5.3. Path Length Acoustic Lenses

9.1.6. Bibliography

9.1.1. Introduction and Summary

The human eye and ear are truly phenomenal instruments for detection of light and sound. It is not possible in reality to improve the sensitivity of these instruments in that the eye is limited by photon energy and the ear is at the threshold of thermal noise. The various optical observing techniques are designed to exploit the human eye. It is the purpose of this discussion to determine whether or not the ear can be exploited using sound-gathering equipment to detect personnel movement in the jungles of Southeast Asia. In order to determine the possible advantages of using sound gatherers, it is first necessary to understand the performance of the human ear. The first part of this report discusses the performance of the ear from a tone, speech and noise viewpoint. Next, the subject matter of jungle acoustics is discussed in which the humidity and terrain loss coefficients of absorption are dominating factors. At this stage of the investigation it does not appear necessary to discuss the temperature and wind diffraction of sound nor the physics associated with the absorption phenomena. Making use of the performance of the ear and terrain and divergence losses for sound pressure, estimates are made on how far certain noises can be heard in a jungle.

We next proceed to the discussion of sound concentrators. The methods of sound concentration considered are:

- 1) mirrors,

- 2) obstacle and path-length lenses, and
- 3) tubular microphones.

It is shown in the discussion on jungle acoustics that the best listening range is around 200 cps, which has a characteristic wavelength of six feet. The reason for the 200 cps wavelength being the best wavelength listening frequency is that the trees and foliage scatter the sounds whose wavelengths are smaller than the sizes of the leaves and limbs of the trees. The 200 cps waves flow over obstacles whose characteristic lengths are smaller than six feet. From an acoustical parabolic mirror viewpoint, it is necessary that the diameter of such mirrors be several wavelengths in diameter in order to achieve directionality and gain. Such devices do not appear to be feasible for transportation through dense jungles but might find application on the perimeter of the jungle. Obstacle and path length acoustical lenses enclosed by horns likewise require large diameters for low frequency listening. Tubular or line microphones achieve directionality by sound interference of waves arriving off axis. Such microphones are highly directional but likewise to achieve directionality and gain in the 200 cps region will require tube lengths in excess of the characteristic wavelength. Hence, these microphones likewise do not appear to be attractive for listening in dense jungles. They do appear to be attractive for application on the periphery of the jungle or for listening at night for noises outside of a stockade. Because of the open range associated with stockades, the lengths or diameters of the acoustic mirrors, lenses, or tubular microphones would not have to be large. The work will have to be extended and representative

sound-gathering equipment be constructed and tested under field conditions to determine the ultimate worth of acoustic listening devices.

9.1.2. hearing

The ear is a very remarkable instrument. It can respond to pressures as low as 10^{-4} dynes cm^{-2} which produces a deflection of the eardrum of about 10^{-9} cm¹. The ear can also withstand sound pressures of 10^3 to 10^4 dynes cm^{-2} . It is just not a pressure sensor but a complex mechanism which in conjunction with the brain becomes a system of filters with the ability to judge loudness, pitch and what can be called musical quality. The ear is at the limit of the pressure fluctuation existing in gases and hence any more sensitivity would result in thermal noise detection. As a starting point for the discussion on jungle acoustics and guerilla warfare, we discuss a few of the performance characteristics of the ear. The information on hearing will be combined with physics calculations on sound propagation to analyze the aural detection problem in the jungle.

9.1.2.1. Loudness (Refs. 9.1. - 9.3.)

The concept of soft, loud, very loud, etc., is placed on a quantitative basis by comparing the sound with a standard sound. The standard sound is chosen as a 1000-cps tone. The loudness of any other sound is defined as the sound pressure level of a 1000-cps tone that sounds as loud as the sound in question. The unit of loudness is

9.1. Acoustics, L. Beranek, McGraw-Hill, 1954

9.2. Acoustical Engineering, M. F. Olson, Van Nostrand, 1957

9.3. Handbook of Noise Control, C. M. Harris, McGraw-Hill, 1957

the "phon." For example, a sound is said to have a loudness of 50 phons if the sound pressure level of a 1000-cps tone of 50-db sounds as loud. Figure 9.1.1 shows the contour lines of equal loudness for normal ears. The phon unit implies that a "jury" of ears is used to measure the sound. A distinction is made between "loudness" and "loudness level." The unit of loudness level is the "phon" which has been defined. The unit of loudness is the "sone." By definition, a loudness of one sone has been arbitrarily selected to correspond to a loudness level of 40 phons. Once again a "jury" of ears are used to answer questions such as "how much louder is a sound of 50 db than a sound of 40 db?" The results of such determinations can be represented within certain limits by

$$\log_{10} N = 0.03 L_M - 1.2$$

where

N = loudness, soncs

L_M = loudness level, phons

Figure 9.1.2 is a nomogram for phons vs. soncs. From a loudness viewpoint let us consider a simple sound consisting of two widely separated tones, say 300 and 2000 cps. If each of the two components had a sound pressure level equal to a 1000-cps tone at 40 db, then each component would have a loudness level of 40 phons when sounded separately. When these tones are judged together a "sound jury" would give a loudness rating close to 50 phons and not 80 phons. Hence on a well-separated tones the sone scale is additive but not on the phon scale. From a noise viewpoint a reduction of 2 soncs to 1 sone is equivalent to

stating that the loudness has been reduced to one-half its former value. In the case of one- and two-ear listening, the sone value is halved when only one ear is used, and hence additional loudness level is required to make the loudness equal to two-ear listening.

9.1.2.2. Differential Sensitivity to Sound Pressure and Frequency (Ref. 9.1)

A person can detect a change in sound pressure level of about 1-db for any tone between 50 to 10,000 cps if the level of the tone is greater than 50-db above the threshold for that tone. For sound pressures less than 40-db, level changes in the range 1 to 3 db are required.

For frequencies above 1000 cps and pressure levels in excess of 40 db, the minimum perceptible change in frequency which the ear can detect is about 0.3 per cent. At frequencies below 1000 cps and pressure levels in excess of 40 db, the ear can detect a change in frequency of as little as 3 cps. At low pressure levels and particularly at low frequencies, the minimum perceptible change in frequency may be many times these values.

9.1.2.3. Masking (Ref. 9.3)

When the noise is so loud that a person cannot hear another sound, that sound is said to be masked by the noise. The same can be said for one noise with respect to another.

Figure 9.1.3 shows the amount by which the tone must exceed the sound pressure spectrum level before it becomes audible. A 200-cps pure note must be ~14 db over the noise before it becomes audible. A

quiet whisper at 5 feet is 10 db as is the rustle of leaves in a gentle breeze. From the loudness viewpoint a change of 15 phons produces at least a doubling of the loudness.

9.1.2 4. Speech (Ref. 9.1)

Studies on the human communication show a speech syllable lasts about 1/8 second and the average interval between syllables is about 0.1 second. The vowel sounds are not critical to speech intelligibility as are the consonants. However, the consonant sounds are weak and hence can easily be masked by noise. The results of monitoring a long-time average speech at a distance of one meter in front of the talker are shown in Figure 9.1.4. The peaks on the root-mean-square sound pressure show a peak pressure of about 50 db around 500 cps. The figure also shows the relationship between the threshold of availability and speech spectrum.

9.1.3. Sound

9.1.3.1. Attenuation

The factors which are important in determining the sound level at a specified position from a point source of sound in open air are as follows:

1. Divergence decreases due to spreading out of energy,
2. Attenuation of sound,
3. Effect of fog,
4. Reflection by and diffraction around solid obstacles,

5. Refraction and shadow formation by wind and temperature gradients.
6. Scattering of sound by small scale temperature and wind variations,
7. Reflection and absorption at the ground.

9.1.3.2. Divergence (Refs. 9.1 - 9.3)

The sound pressure level is by definition 20 times the logarithm of the ratio of the determined sound pressure to the reference sound pressure, i.e.,

$$SPL = 20 \log_{10} \frac{P}{P_{ref}} \text{ db}$$

In the United States P_{ref} is usually taken as 0.0002 microbar (2×10^{-5} Newtons m^{-2}) which is the hearing limit for the 1000 cycles per second region. Since pressure falls off inversely as distance, we have

$$SPL = 20 \log_{10} \frac{P}{r_x} \text{ db}$$

The doubling of the distance results in a 6-db change. Hence, if the sound pressure level is L_x at a distance x from a source, then the sound pressure level L_p at a distance r is

$$L_p = L_x - 20 \log_{10} \frac{r}{r_x} \text{ db}$$

9.1.3.3. Absorption

a) Air Absorption

The passage of very high frequency sound waves through dry air are damped by viscosity,

thermal conductivity and rotational states of the molecules. Since we are interested in the audio range we will not concern ourselves with these interesting theoretical aspects of the absorption problem. Acoustical relaxation in the audio range is influenced by the humidity. The humidity dependence of the absorption coefficient for air at 20°C is shown in Figure 9.1.5 (Ref. 9.2).

The curves show quite clearly that the high frequency sounds are damped quite readily. Comparing Figures 9.1.1 and 9.1.5 it appears that some frequency discrimination would occur at long distances for the 1500-10,000 cycles per second frequency range. Low frequency sounds are not attenuated but the sound pressure threshold is equivalent to ~ 50 decibels greater than the ~ 1000 cycles per second threshold. An absorption coefficient of 0.0002 per centimeter reduces the intensity of a plane wave by a factor of e^2 (~ 7.4) in 100 meters. The laboratory measurements of Knudsen were checked for tropical conditions over a hard base by Eyring. A comparison of observations made at 55 per cent relative humidity and 80°F is given in Table 9.1.1.

Table 9.1.1
FREQUENCY DEPENDENCE OF SOUND ATTENUATION
AT 55% RELATIVE HUMIDITY AT 80°F

Frequency cps	75	150	300	600	1200	2400	7000	10,000
	150	300	600	1200	2400	4800		
Field (Eyring) dB/ft	0	0	0.01	0	0.015	0.011	0.020	0.045
Laboratory (Knudsen)db/ft	0	0	0	0.001	0.002	0.006	0.019	0.033

It is apparent that high frequencies are damped out in short distances by absorption alone. High frequency damping effects are easy to observe. For example: the decrease in intensity of high frequency relative to lower frequency noise of a jet plane as it leaves the embarkation point is the result of high frequency absorption; the general decrease in overall level is the result of divergence. Further, the boom of distance guns or lightning can be explained by high frequency absorption.

b) Forest Absorption

The leaves, branches, and trunks of foliage will scatter sound waves whose characteristic lengths are less than the characteristic lengths of the vegetation. Hence, one would expect that high frequency sounds would be attenuated rather rapidly in a jungle. The lower frequency sounds would also be attenuated by general sound absorbing properties of the foliage but would attenuate much less than the high frequency components. There appears to be little data on jungle terrain sound absorption. The only studies known to the author were carried out in Panama during World War II. (Refs. 9.4 and 9.5) The terrain loss coefficient in decibels per foot as a function of frequency are shown in Figure 9.1.6.

The hearing sensitivity curve shown in Figure 9.1.1 when superimposed on the terrain loss curve shown in Figure 9.1.6

9.4 "Jungle Acoustic," C. Eyring, J. Acoustical Soc. of America, 18, 257-270 (1946)

9.5 "Ultrasonic Ambient Noise in Tropical Jungles," J. Saby and H. Thorpe, Ibid 18, 271-273 (1946)

indicates that there is an optimum frequency for listening. The optimum frequency for hearing distant sounds is around 200 cycles per second. The terrain loss coefficients at 200 cps for the jungles, described in terms of seeing distance and ease of penetration are given in Table 9.1.2.

Table 9.1.2

TERRAIN LOSS COEFFICIENTS FOR JUNGLE AT 200 cps (Ref. 9.4)

Type of Jungle	db/ft
Leafy, seeing distance 20 ft, penetration by cutting	0.04
Leafy, seeing distance 50 ft, penetration difficult without cutting	0.03
Leafy, seeing distance 100 ft, free walking with care	0.02
Little leafy growth with large bracketed trunks, seeing distance 300 ft, penetration easy	0.015

c) Sound Masking Level in Jungle

The masking level curves for a very dense jungle are shown in Figure 9.1.7. It is to be noted that the best listening frequency range is slightly noisier in the daytime than at night. A crude estimate would be that one could hear a low frequency noise twice as far at night as by day. This estimate is based on fundamental relationship that a 6-db loss is equivalent to doubling the distance from source to observer.

9.1.4. Listening Distances in the Jungle

Let us now estimate how far one can distinguish sounds in the jungle. Based on Figure 9.1.3 we will assume that 15 decibels above noise can be surely detected. Further, based on Fig.9.1.7 we will assume that a very quiet jungle has a masking level of 15 db. On the basis of these two assumptions, the minimum detectable signal is about 30 db. Table 9.1.3 gives representative noise levels and sources.

Table 9.1.3

NOISE LEVELS AND SOURCES (Refs. 9.1, 9.3, 9.6)

<u>Source of Noise Description</u>		<u>Decibels</u>
Threshold of pain		130
Hammer blows on steel plate	2 ft	114
Riveter	35 ft	97
Lion roaring	18 ft	87
Motor truck changing gears	15-20 ft	74
Busy street traffic		68
Ordinary conversation	3 ft	65
Sawing wood	30 ft	61
Restaurant		60
House in country		40
Average whisper	4 ft	20
Quiet whisper	5 ft	10
Rustle of leaves in gentle breeze		10

Let us now estimate how far an ordinary conversation might be heard in a jungle. To make the estimate, let us assume that a flat masking level of 20 db exists and that the speech detection signal is 15 db above the

9.6 "Results of Noise Survey," R. Galt, Ibid 2 410-418 (1970)

noise. We are differentiating between intelligibility and detection of speech. The root-mean-square speech level is 65 db at 3 feet. The assumed permissible decibels of attenuation is 30. To attenuate 30 db by geometry alone would require 96 feet. If an overall terrain coefficient of $\alpha = 0.05$ is assumed, a person talking in the jungle would be heard at about 75 feet. If the masking level were 26 db instead of 20 db, the listening distance would be reduced by approximately one half.

In the case of a louder sound, let us estimate how far a roaring lion could be heard. According to Table 9.1.3, a roaring lion would be equivalent to 102 db at 3 feet. Assuming an overall masking level signal-detection of 30 db, we calculate that the lion could be heard in the open at a distance of 12,000 feet (~2.3 miles). (We have neglected diffraction of sound in making this estimate.) The distance the lion could be heard in the representative jungle is 600 feet. The roar would be peaked at about 200 cps.

Tests were carried out in Panama in 1944 on the distance a 2-1/2 ton Army truck could be heard in the jungle. Figure 9.1.8 shows the masking level, threshold hearing curve for average soldier, a wind-noise frequency curve and a truck noise frequency.

The overall sound level for the truck was 75 db at 100 feet, which would be equivalent to 105 db at 3 feet. Based on a 26-db masking level and 14 db additional signal for detection of a peak tone around the 200-cps range, Table 9.1.4 indicates that the listening distance is 600 feet. An observer who was known to have better listening ability than the average in the frequency range below 300 cps was able to detect the truck

a distance of 1000 feet by listening for peak sounds. (Ref. 9.4) Once again the calculations are only estimates for one does not know the noise level taken at the listener location nor many other factors which could make a difference of several db. Lowering the noise level by 6 db revises the listening distance calculation to less than 700 feet. According to Table 9.1.4, 1000 feet corresponds to an attenuation of 94.4 db. The calculations are not agreeing with the experiment. If just noise level was a criterion, then some of the discrepancy can be accounted for. For sound pressures less than 40 db, pressure level changes of 1-3 db can be detected. (Ref. 9.1) In terms of sones, a 3 db (or phons) change at a 40-db level would increase the loudness about 30 per cent. If the detection of the truck was made on noise loudness and not distinguishing a truck sound, then the 14 db above masking level could be neglected. The detection distance for noise level change would be about 800 feet which is in acceptable agreement with the observation of 1000 feet.

It is apparent that more information on sound attenuation under jungle conditions would be required to improve the estimates. However, it is apparent that the jungle can be likened to a room with sound-absorbing walls that has a rather high noise level. The walls being the foliage and the jungle being the source of noise.

9.1.5. Devices

9.1.5.1. Parabolic Reflectors

Sound like light can be concentrated with reflectors whose geometries are such that the reflected rays are focused. The wavelength for 4000°A light is 4×10^{-5} cm and the wavelength for 300 cps

sound is ~4 feet. Hence, although the principles are the same, the characteristic diameters are much greater for sound collectors. In the case of sound-reflectors, surface imperfections are not significant. The parabolic reflector is so shaped that the pencils of sound incident on the surface are focused at a point. It is apparent that in order to obtain a gain in pressure at the focus, the diameter of the reflector must be several times the wave or else the wave will just flow past the collector. Figure 9.1.9 shows the results of some experiments on a parabolic reflector 3 feet in diameter. The directional characteristics of the microphone are very sharp at 8000 cps (~1.3-ft wavelength) and nondirectional at 200 cps (~4-ft wavelength). For listening to bird calls and watch-ticking, a 3-ft diameter reflector would provide direction and gain. The gain is directionally proportional to the cross sectional area of the reflector and inversely proportional to the square of the wavelength.

9.1.3.2. Obstacle Array Acoustic Lenses

The velocity of sound is by definition

$$\sqrt{\frac{\partial p}{\partial \rho_s}}$$

where

p = pressure

ρ = density

s = entropy

For an ideal gas the velocity of sound is given by

$$\sqrt{\frac{\gamma p}{\rho}} \text{ or } \sqrt{\gamma RT}$$

TABLE 9.1.4 SOUND ATTENUATION IN JUNGLE: $L = 20 \log \frac{x_2}{x_1} + \alpha(x_2 - x_1)$, $x_1 = 3$ Feet

Distance x_2 feet	Divergence Loss db	Frequency Range & Average Terrain Loss			Total Attenuation for Best Listening Range $\alpha = 0.05$, db
		$\alpha = 0.05$ 200-400 cps	$\alpha = 0.07$ 500-1000 cps	$\alpha = 0.2$ 5000-10,000 cps	
25	18.4	1.10	1.54	4.40	19.4
50	24.4	2.20	3.08	8.80	26.4
100	30.4	4.40	6.16	17.60	34.8
125	32.4	5.50	7.70	22.0	37.9
150	33.9	6.60	9.24	26.4	40.5
200	36.4	8.80	12.32	35.2	45.2
250	38.4	11.00	15.40	44.0	49.4
300	39.4	13.20	18.48	52.8	52.6
400	42.4	17.60	24.64	70.4	60.0
500	44.4	22.00	30.80	88.0	66.4
600	45.4	26.40	36.96	105.6	71.8
700	47.2	33.00	43.12	123.2	80.2
800	48.4	35.20	49.28	140.8	83.6
900	49.3	39.60	55.44	158.4	88.9
1000	50.4	44.00	61.60		94.4
2000	56.4	88.00	123.20		
4000	62.4	176.00			
8000	68.4				

Hence, changes in density at constant pressure result in velocity changes. The definition of refractive index is the ratio of the velocity in one media to velocity in another media. The placing of obstacles in arrays alters the properties of the media. The refraction resulting from the immersing of obstacles in a media can be explained by two approaches to the problem. When the characteristic length of the object is much smaller than the characteristic length of the wave, the obstacle can be considered (1) as a source of reradiation, or (2) as a means of changing the density. The simplest obstacles are spheres. The explanation is valid for electromagnetic waves as well as acoustic waves.

a) Array of Spheres (Ref. 9.7)

In the case of electromagnetic waves, the spheres are considered as electrically conducting and in the case of sound waves the spheres are considered as immovable (rigid bodies) objects. The reradiation explanation is based on the spheres becoming small electric or acoustic dipoles. The resultant of the original wave and the reradiated waves form a wave having a lower velocity inside the array.

A physical approach to the lower velocity can be obtained as follows. The dielectric constant of free space is unity. The immersion of perfect conducting metal spheres into free space increases the dielectric constant. Hence, the index of refraction

9.7 "Refracting Sound Waves," W. Koch and F. Harvey, Ibid, 21 471-481 (1949)

becomes greater than unity. Likewise, the immersion of infinitely dense (rigid) spheres into air whose relative density is unity results in a media having a refractive index greater than unity. Since the velocity of sound in air decreases with an increase in the density at constant pressure, we need to find an explanation as to why the density of the gas inside the array is greater than in free space. The hydrodynamics of a sphere moving in an incompressible fluid flow at velocities shows that the sphere has a virtual mass equal to 1/2 the mass of the displaced fluid. A sound wave flowing over fixed sphere acquires an effective mass. The density would appear to be

$$\rho = \rho_0 + 1/2 \rho_0 V$$

where V is the volume of the sphere. Hence, the effective density for an array of N spheres per unit volume with a radius a would be

$$\rho = \rho_0 + \frac{2\pi}{3} \rho_0 a^3 N$$

The refractive index, n , for the sphere array is given by

$$\left(\frac{v_0}{v}\right)^2 = n^2 = 1 + \left(\frac{2\pi}{3}\right) N a^3$$

b) Array of Solid Bodies (Ref. 9.7)

In the case of incompressible fluid flow the theoretical results show that all moving bodies should be affected by the virtual mass of the body. Hence, the masses enter in the form of $M + kM^1$, where M^1 is the added mass and k is coefficient depending on the shape. Hence arrays of irregularly shaped objects

would have an index of refraction given by

$$n^2 = 1 + kN$$

where N is number of obstacles per unit volume. Figure 9.1.10 shows the indices of refraction for simple arrays.

Figure 9.1.11 shows the construction of a simple six-inch diameter disk lens and feed horn which was tested at 13.4 kc.

The directional pattern of the lens and horn combination is shown in Figure 9.1.12. It should be noted that the lens diameter was six times the wavelength (1.01") and the wavelength was twice the diameter of the disks.

It is apparent that acoustic lenses of the obstacle array type are easy to construct. However, for good jungle listening at 200 cps the size of the lens would need to be several wavelengths which would mean a cross sectional diameter of 20 feet. A lens in Figure 9.1.12 scaled for 200 cps with performance characteristics would be 24 feet in diameter and have disks 2-feet in diameter.

9.1.5.3. Path Length Acoustic Lenses

The delay time associated with the virtual mass in obstacle arrays can be achieved by mechanical devices to increase the path length. Figure 9.1.13 shows serpentine plates and slant plates as path length increases. The indices of refraction are given by

$$n = \frac{l}{l_0}$$

where

l = path length through the plates

l_0 = path in the absence of the plates

The index of refraction for the slant plate is given by

$$n = \frac{l}{l_0} = \frac{1}{\cos \theta}$$

where

θ = angle between direction of propagation of the wave and the plane of the plates.

Figure 9.1.14 shows how the serpentine plates can be used to obtain converging lenses, diverging lenses and prisms.

A schematic drawing of the operation and construction of a slant plate acoustic lens enclosed by a conical horn is shown in Figure 9.1.15.

The directional performance of a lens-horn microphone with a 29-inch aperture and 30-inch focal length is shown in Figure 9.1.16. (Ref. 9.8)

It should be noted that the directional properties are quite good at wavelengths only slightly smaller than the aperture. The gain varies as the square of the aperture wavelength ratio.

9.8 "An Acoustic Lens as a Directional Microphone," Trans. of IRE 1, 3-7 (1954)

9.1.6. Bibliography

"A Space Time Pattern Theory of Hearing," H. Fletcher, JACS 1, 311-343 (1930).

"Sound Concentrator for Microphones," d. Olson, JACS 1, 410-418 (1930).

"Results of Noise Surveys," R. Galt, JACS 2, 30-(7) (1930).

"Comments on the Theory of Horns," W. Hall, JACS 2, 552-561 (1931-1932).

"On Minimum Audible Sound Fields," L. Sivian and S. White, JACS 4, 288-321 (1932-1933).

"On the Theory of Sound Absorption of Porous Materials," M. Rettinger, JACS 6, 188-191 (1935).

"Reducing Noise in Airplane Sound Locators," E. House, JACS 7, 127-134 (1935).

"Relation Between Loudness and Masking," H. Fletcher and W. Munson, JACS 9, 1-10 (1937).

"Loudness, Masking and Their Relation to the Hearing Process and the Problem of Noise Measurement," H. Fletcher, JACS 9, 275-293 (1938).

"Theoretical and Experimental Investigation of the Transmission of Sound Over Reflecting Surfaces," G. Diene and A. Noyes, JACS 9, 193-204 (1938).

"Effects of Physical Size on the Directional Response Characteristics of Unidirectional and Pressure Gradient Microphones," J. Massa, JACS 10, 173-179 (1938).

"A Tubular Directional Microphone," W. Mason and R. Marshall, JACS 10, 206-215 (1939).

"Loudness of Continuous Space Noise and Its Application to Loudness Measurements," F. Brattain, JACS 11, 113-117 (1939).

"Power Transmission Loss in Exponential Horns and Pipes with Wall Absorption," W. Phelps, JACS 12, 68-74 (1940).

"Absolute Noise Level of Microphones," H. Baerwald, JACS 12, 131-139 (1940).

- "Uniphase-Unidirectional Microphone," B. Bauer, JACS 13, 41-45 (1941).
- "Acoustical Amplification for Hearing Aids," P. Sabine, JACS 16, 38-44 (1944).
- "Generalized Plane Wave Horn Theory; New Family of Horns," V. Salvon, JACS 17, 199-218 (1946).
- "Jungle Acoustics," C. Eyring, JACS 18, 257-270 (1946).
- "Ultrasonic Ambient Noise in Tropical Jungles," J. Saby and H. Thorpe, JACS 18, 271-273 (1946).
- "Theory of the Propagation of Sound Scattering and Absorbing Materials," M. Givens, W. Nyborg and H. Schilling, JACS 18, 284-295 (1946).
- "Generalized Solutions of Webster's Horn Theory," O. Mawardi, JACS 21, 325-330 (1949).
- "Variational Principles of Acoustic Refractions Theory," H. Levine, JACS 22, 48-55 (1950).
- "Loudness Patterns - A New Approach," W. Munson and M. Gardner, JACS 22, 177-190 (1950).
- "Response Peaks in Finite Horns," C. Molloy, JACS 22, 551-588 (1950).
- "Resonance Characteristics of a Finite Catenoidal Horn," C. Theissen, JACS 22, 558-562 (1950).
- "A Second-Order Gradient Noise Cancelling Microphone Using a Single Diaphragm," W. Beaverson and A. Wiggins, JACS 22, 592-601 (1950).
- "On the Masking Pattern of a Simple Auditory Stimulus," J. Egan and H. Hake, JACS 22, 622-630 (1950).
- "Binaural Localization and Masking," W. Kock, JACS 22, 801-(?) (1950).
- "Scattering and Absorption by an Acoustic Strip," A. Levitas and M. Fox, JACS 22, 316-322 (1950).
- "Theory of Sound Absorptive Materials," C. Harris and C. Malloy, JACS 24, 1-7 (1952).

"A Miniature Microphone for Transistorized Amplifier," B. Bauer, JACS 25, 867-869 (1953).

"Acoustic Lens as Directional Microphone," M. Clark, JACS 25, 1152-1153 (1953).

"Unidirectional Microphone Utilizing a Variable Distance Between Front and Back Diaphragm," A. Wiggins, JACS 26, 687-692 (1954).

"Sound Propagation into the Shadow Zone," D. Fridmore-Brown and U. Ingard, JACS 27, 36-42 (1955).

"Diffraction of Elastic Waves," L. Knopf, JACS 28, 217-229 (1956).

-9.24-

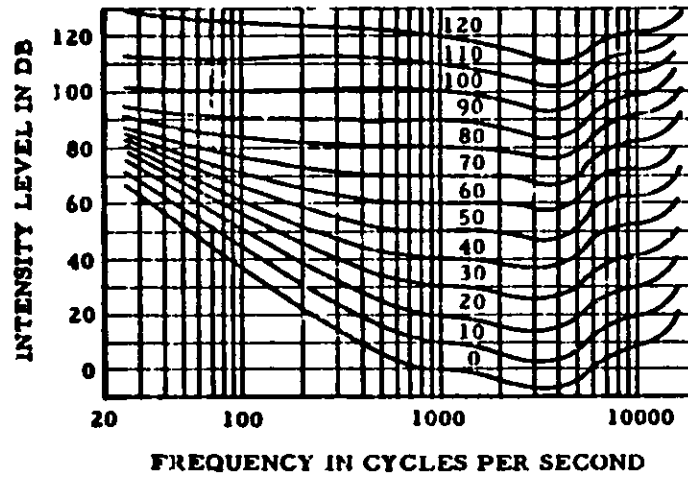

Figure 9.1.1 - Contour lines of equal loudness for normal ears. Numbers on curves indicate loudness level in phons. 0 db = 16^{-16} watts per square centimeter. 0 db = 0.000204 dyne per square centimeter. (After Fletcher and Munson.)

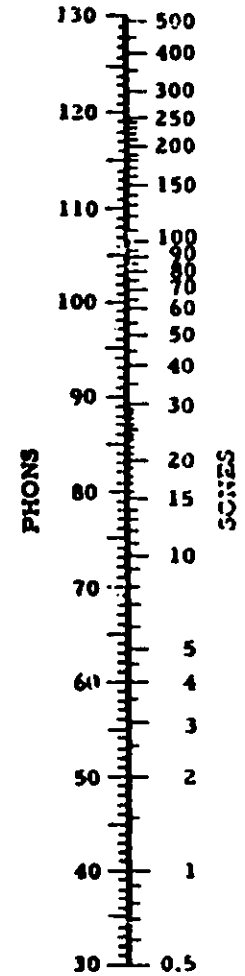

Figure 9.1.2 - Nomogram giving the relationship between loudness in sones and loudness level in phons.

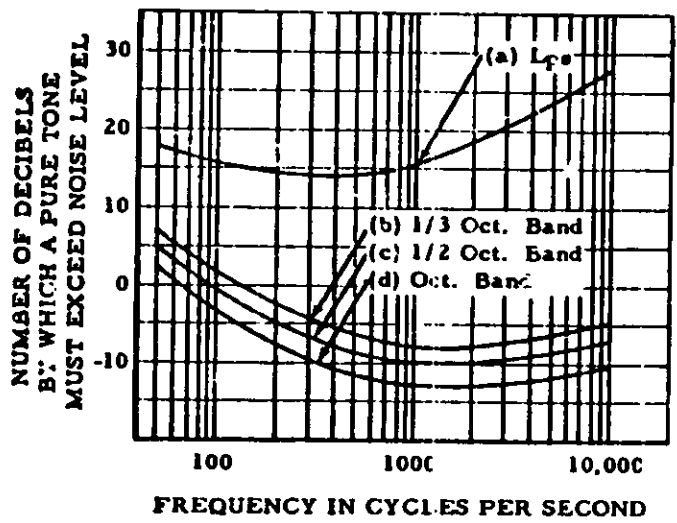

Figure 9.1.3 - The number of decibels which a pure tone must be raised above the level of noise for the tone to be just audible in the presence of the noise. The upper curve shows the amount which the tone must exceed the sound-pressure spectrum level before it becomes audible. Curves are also given showing the amount by which the tone must exceed various band levels to be just audible.

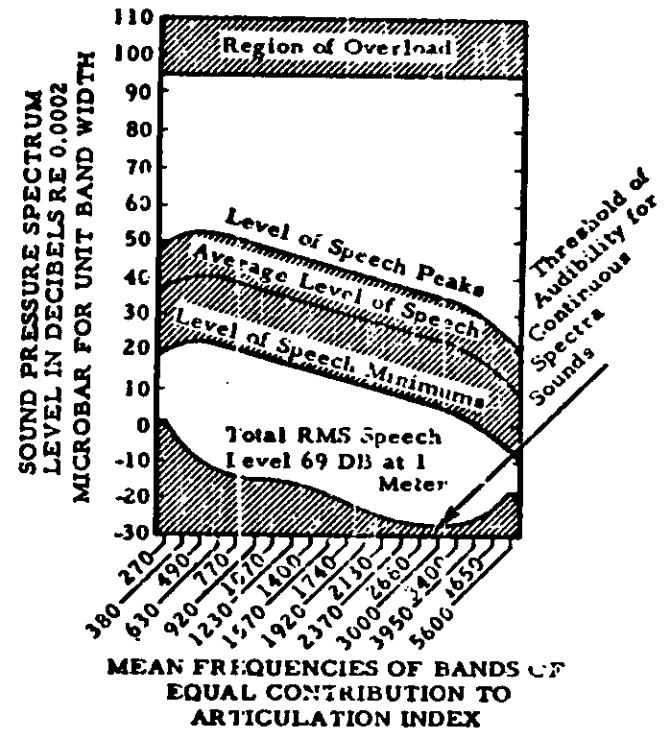

Figure 9.1.4- Plot, on a spectrum level basis, of (1) the speech area for a man talking in a raised voice; (2) the region of "overload" of the ear of an average male listener; and (3) the threshold of audibility for young ears. All curves are plotted as a function of frequency on a distorted frequency scale. [After Beranek, Proc. RE, 35: 880-890 (1947).]

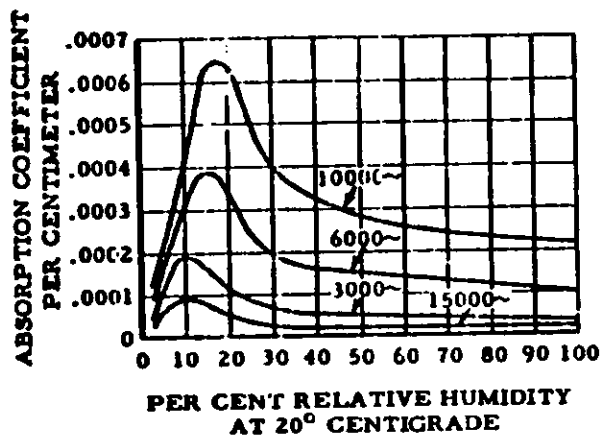

Figure 9.1.5- Curves showing the absorption of a plane sound wave in passing through air, at 20° Centigrade, for different frequencies, as a function of the relative humidity. The intensity after a plane wave has traveled a distance x centimeters is $I_0 e^{-mx}$, where I_0 is the intensity at $x = 0$ and m is the coefficient given by the above graph. (After Knudsen.)²

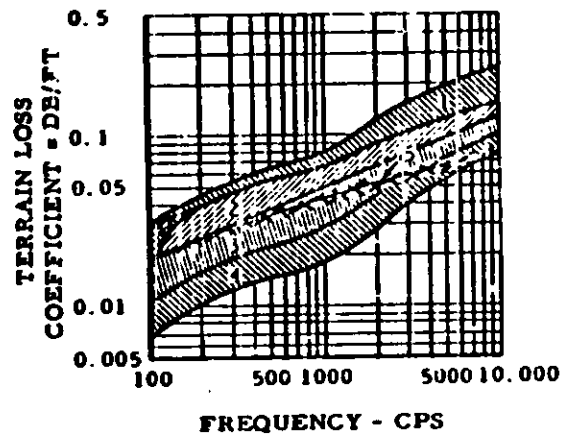

Figure 9.1.6- A chart from which to estimate terrain loss coefficients for tropical jungles. Zone 1, very leafy, one sees a distance of approximately 20 ft., penetration by cutting; zone 2, very leafy, one sees approximately 50 ft., penetrated with difficulty but without cutting; zone 3, leafy, one sees a distance of approximately 100 ft., free walking if care is taken; zone 4, leafy, one sees a distance of approximately 200 ft., penetration is rather easy; zone 5, little leafy undergrowth, large bracketed trunks, one sees a distance of approximately 300 ft., penetration is easy.

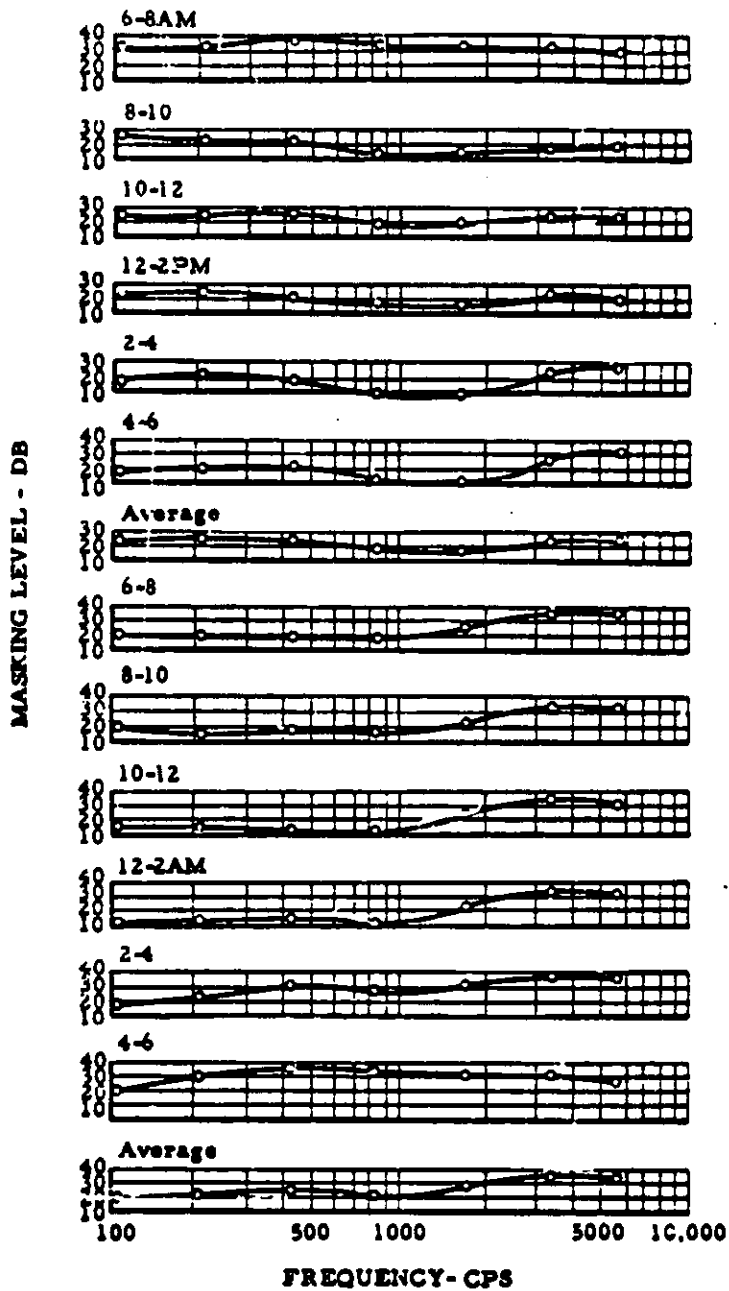

Figure 9.1.7- Masking Level Curves, Las Cruces Jungle.

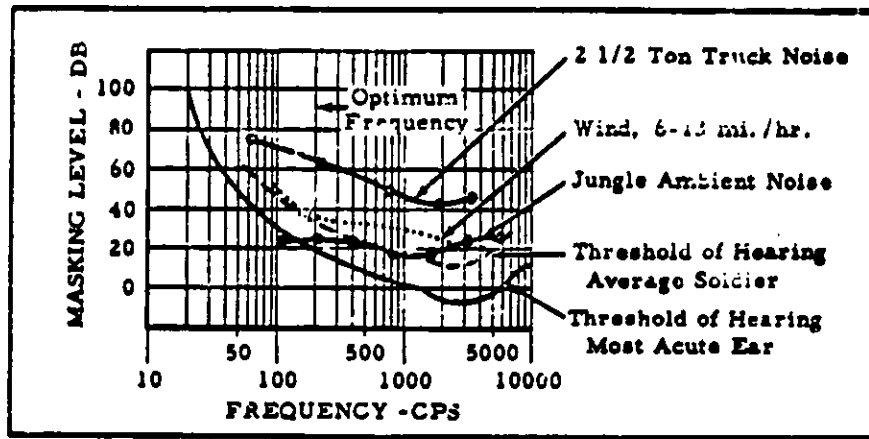

Figure 9.1.8 - Masking Level Curves and Motor Noise. ⁴

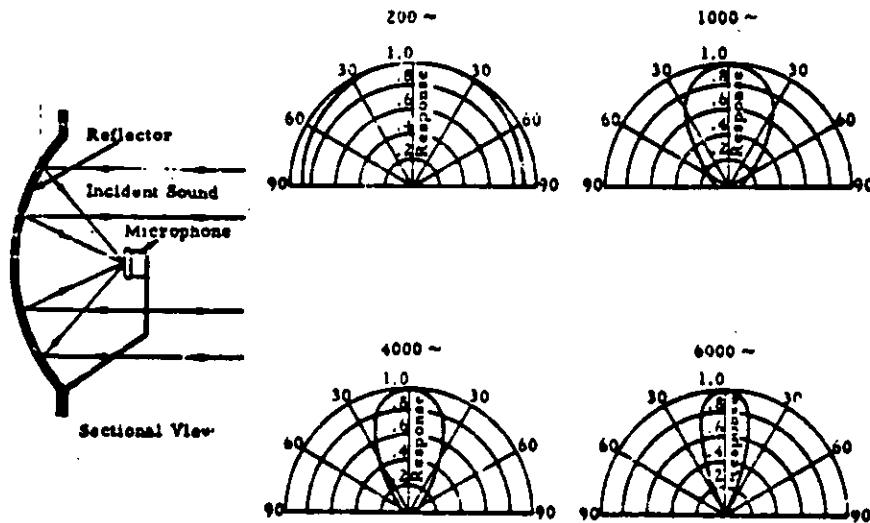

Figure 9.1.9 - Cross-sectional view of a parabolic reflector for a microphone. The polar graphs show the directional characteristics. The polar graph depicts the pressure, in dynes, at the microphone as a function of the angle, in degrees. The maximum response is arbitrarily chosen as unity.

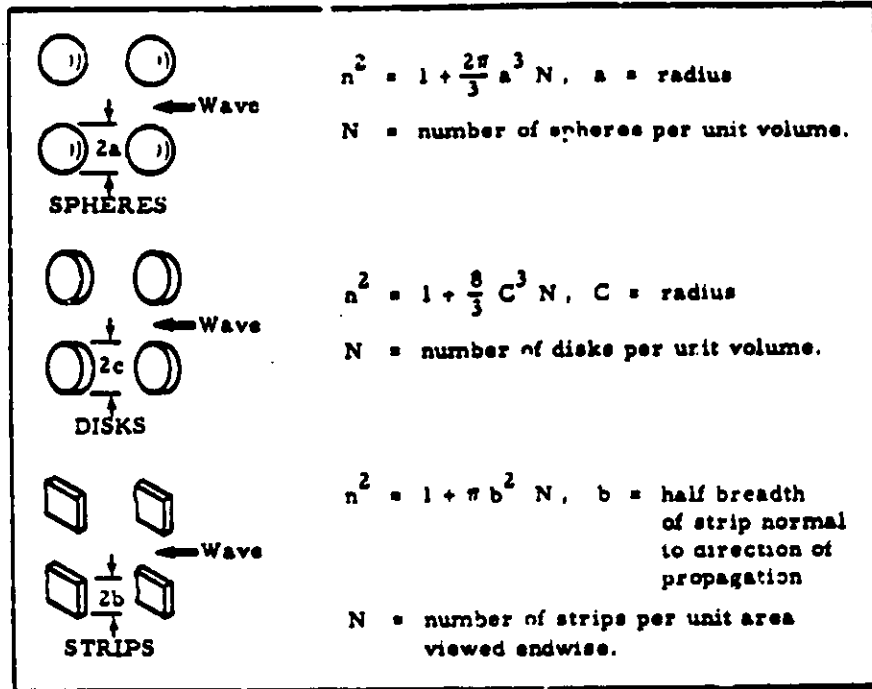

Figure 9.1.10- Index of Refraction for Rigid Element Acoustic Diffraction Arrays.

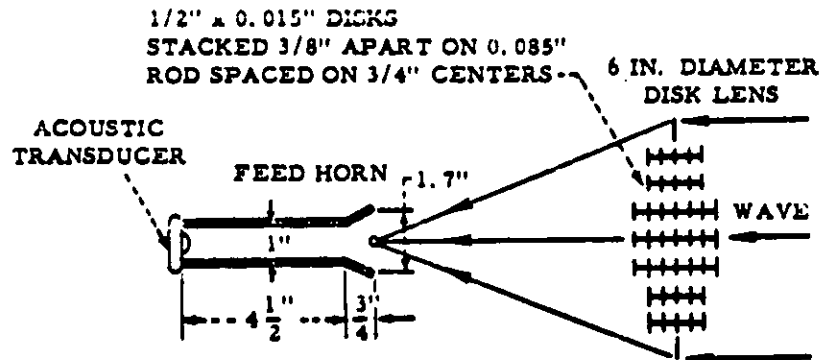

Figure 9.1.11 - Disk Lens for High Frequency Sound Collection.

-9.30-

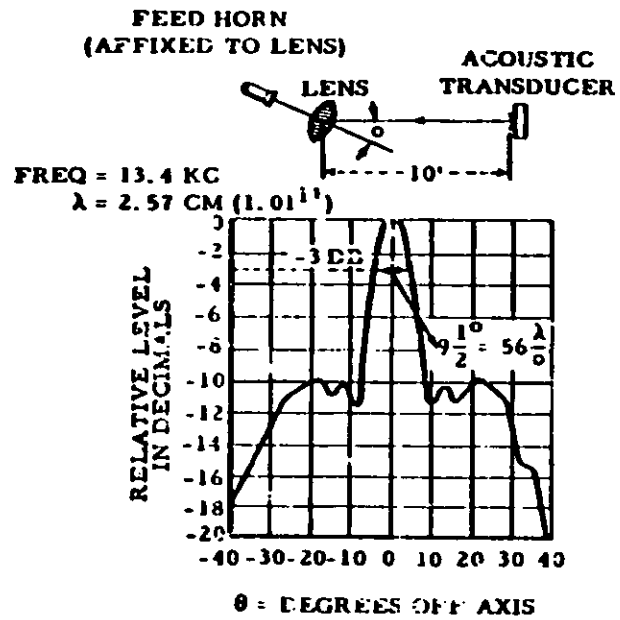

Figure 9.1.12 - Directional Properties of a High Frequency Acoustic Lens.

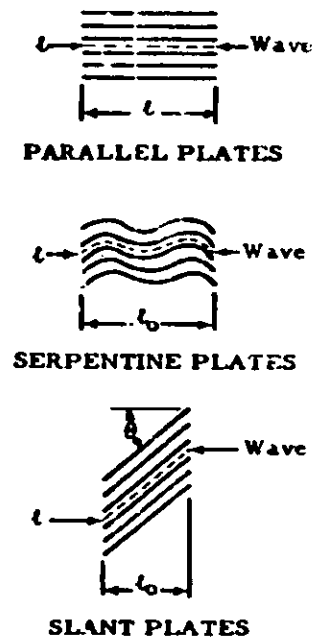

Figure 9.1.13 - Acoustic Path Lengths.

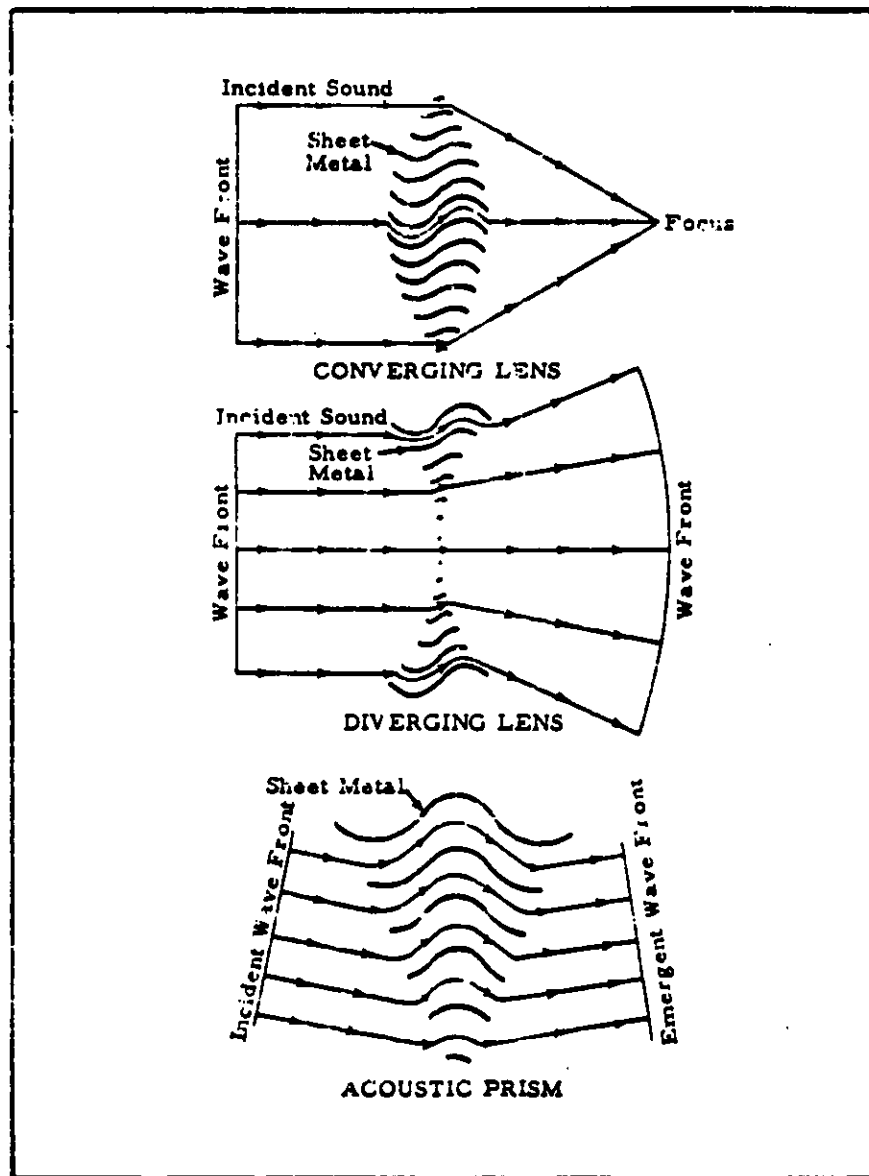

Figure 9.1.14 - Acoustic Lenses and Prism. 2

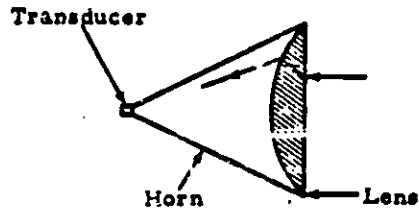

Figure 9.1.15 - Slant-Plate-Lens-Horn Microphone.

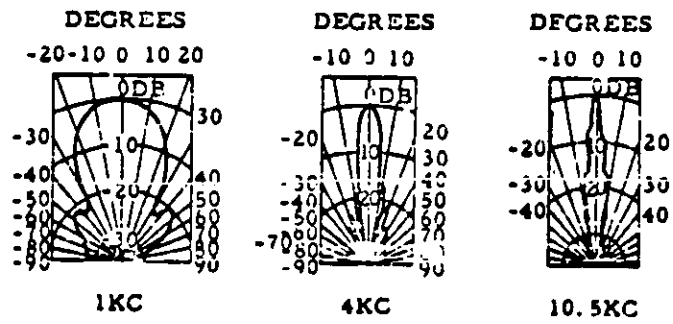

Figure 9.1.16 - Directional characteristics of a 29 inch diameter, 30 inch focal length slant-plate-lens-horn microphone.

9.2. Applications Problems

As discussed above, sound can be collected by a variety of devices. [Not discussed above is the line or "machine gun" microphone consisting of a bundle of tubes of different lengths, or its variants like the Electro-voice Model 642, which achieve high directionality in small volume by the disturbed sound entrance to the diaphragm. Such microphones are very popular in movie and television work where repression of area noises is desirable.] Many of these, or similar, devices could be manufactured from natural materials. For example, it was suggested early by B. Alexander that one could design exponential horns for mounting on the guard towers of strategic hamlets for night-time listening. This, and other ostensibly useful applications have not been pursued under this contract for lack of established requirements and data on backgrounds.

There are several difficulties here. First, as discussed in 9.1, the design of an equipment for a given purpose is strongly affected by the nature of the signals sought and characteristic noise backgrounds. There are not many data on these from the conflict area. Second, the nature of the operation, whether it be area or line-surveillance, for example, is quite important. In the strategic hamlet problem, for example, it would seem desirable to pattern the surveillance after warning requirements, lines of fire control and local factors. Each problem may be somewhat different. It may be, for example, that in one village a horn, or other device, for area surveillance would be best, whereas in another a distant barrier line of microphones might be better. Under certain circumstances, high directionality with low gain may be desired.

Third, while sound collectors may be reasonably constructed of naturally occurring materials, considerably enhanced performance may be achieved depending on associated electronics, which probably cannot be manufactured locally.

A desirable prelude to work on acoustic gadgetry, and even to the testing of various available devices, would be a survey of requirements. This involves determining what sort of acoustic detection is wanted, what kind of surveillance operation is desired, and if possible, what the local noise characteristics are.

Given this information it is a relatively simple matter, considering industrial U. S. acoustic capability to design the required equipment.

Since these requirements and associated data have not been obtainable, the work on this contract has been restrained to an examination of such basic factors as were known.

9.3. Geophysics

Geophysical prospecting methods may be of some interest in specialized anti-guerilla operations (ref. 9.9: 9.10). Although the use of geophones is a natural application, since they are highly sensitive [perhaps 100 yds. or more on foot falls can be reliably distinguished by a trained operator], geophones and other seismic methods have not been investigated in this study as it was understood that such techniques were being covered by NOTS, Inyokern.

The only geophysical method examined, and that briefly, was the possible application of magnetic detection methods to

o Detection of ferromagnetic weapons carried by personnel, particularly under conditions of routine inspection or surveillance and at short ranges;

9.9 Slichter, L. B. Geophysics Applied to Prospecting for Ores
Inst. of Geophysics No. 60 U. of California

9.10 Dobrin, M. B. Introduction to Geophysical Prospecting McCraw Hill, 1960

- °Detection of concealed weapon stores;
- °Detection of underground burrows or caves;
- °Detection of ambushes, etc.

Four types of technique might be applicable; (1) a passive, stationary detector to register moving targets; (2) a passive, portable detector, to register stationary targets; and their possible counterparts including an active element to subject the nearby target to a strong field. The latter, of course, are easily rejected as a simple estimate shows that prohibitively large fields are required to produce DC fields comparable to the Earth's field at ranges of 10 feet.

In general, the problems are familiar. The objects to be detected are small. They create a small perturbation in the earth's field (at interesting distances) which may be comparable to noise in the field. The background fluctuations are poorly known in areas of interest, and temporally. However, simple calculations lead to estimated effects which are marginally interesting and, therefore, investigation is warranted. A crude measure of the region of applicability is indicated by an account in Skiing, (ref. 9.11) of the use of the Varian M-49 magnetometer to detect magnets in the boots of skiers buried under the snow. It is stated that 1-3/4" magnets were located under 13 feet of snow. [The M-49 is a moderately good magnetometer ($\pm 5\gamma$) leased by Varian at some \$330 per month.]

One fact which makes magnetic detection very difficult if not completely unfeasible, is that the field falls off as the inverse cube of distance. Increasing magnetometer sensitivity does not seem to be the answer because of noise and decreasing the detection range increases the probability of

9.11 _____ Skiing Vol. 15[3]1962, Dec.

detection but decrease the coverage or mobility of the device. Another is noise.

Rubidium vapor magnetometers (Rb^{85} , Rb^{87}) where the Zeeman separation of sublevels is of the order of 5 cycles/sec/gamma, have been used to measure low-intensity, low-gradient fields. These magnetometers have very good stability and a sensitivity which is often quoted at about 0.02 gamma.

In early 1961 two Model X-4934 research Rb vapor magnetometers were used to measure magnetic field intensity. (ref. 9.12) The output was a voltage proportional to the magnetometer Larmor frequency (4.667 cycles/sec/gamma) which is conveniently recorded. The width scale employed was 20γ with 28 divisions which allowed distinctions of 0.02 gamma on the chart. Some records taken on March 27 showed some micropulsations with periods of a minute or greater and with amplitudes slightly less than 1γ. After a small magnetic storm occurred the field remained disturbed. During early afternoon, micropulsations with periods of about 20 seconds and amplitudes of 0.6 - 0.8 gamma occurred. Throughout the late afternoon and evening, a broader oscillation occurred, with periods like an hour or more, and amplitudes of 10s of gamma.

There are, in fact, several natural sources of noise which will make detection of small bodies at interesting distances difficult. The noise has a wide range of frequencies, amplitude and scale. The very low frequencies will give little trouble. The annual change is about 50γ and the diurnal change is about 20γ. The noise resulting from ionospheric phenomena (termed magnetic storms) having amplitude of 100γ and periods of seconds may give considerable trouble. The geographical scale of these fluctuations do not seem to be known. If the scale is small (less than the detection

9.12 Varian Corp. Geophysics Technical Memorandum No. 7 March 1961

range) the problem is extremely difficult. If the scale is large, all measurements could be compared to a detector at a base station. Mineral deposits will give very large amplitude signals (10^5), the largest ever measured, was observed over an iron deposit in Russia; however, these signals are reproducible and have scales of kilometers.

A third difficulty, of course, would be the presence of (friendly) weapons in the vicinity of the testing instrument.

Following the method of Slater and Frank (ref. 9.13) the field inside and outside a uniformly magnetized sphere placed in an originally uniform field, H_0 , was determined. The expression for the field outside the sphere is

$$\vec{H} = \vec{H}_0 - \text{grad} \left(\frac{H_0 R^3 \cos \theta [\mu - 1]}{r^2 [\mu + 2]} \right) \quad (1)$$

where μ is the relative permeability, R is the sphere radius, and r and θ are the coordinates of the point of interest. An interesting case is a sphere having high permeability ($\mu > 10$), which would include mainly ferromagnetic materials. In this instance omitting the terms $\frac{\mu - 1}{\mu + 2}$ will introduce less than 25% error. This indicates the field outside a sphere is independent of the permeability when it is greater than about 10 times the free space value. The maximum field strength, $3H_0$, occurs at the poles. The field strength at the equator is zero. The field falls or rises to the undisturbed field strength as $\left(\frac{R}{r}\right)^3$ in all radial directions. If H_0 is the earth's field (roughly one gauss) and a one-tenth gamma (10^{-6} gauss) disturbance in the field can be detected. (As indicated above, this value is

9.13 Slater, J.C. and Frank, N.H. Electromagnetism McGraw Hill(1947)pp 72-74

appropriate to modern magnetometers), the sphere could be detected at a distance of 10^7 radii.

An estimate of the disturbance in the magnetic field caused by a cavity in the earth is made in similar fashion. The problem is like the case of a magnetized sphere in a uniform field. Here a solution was obtained by adding the field of an isolated magnetized sphere to the uniform field. The cavity having a lower permeability than the earth will produce an effect which is opposite to that produced by the sphere. The field will be decreased at the poles and increased at the equator; however, equation (1) can be used by merely changing the sign of the gradient. Two serious problems are encountered, (1) the permeability of the earth is nearly one but highly variable and (2) the field of interest is above the earth's surface; therefore, two interfaces are involved. The first factor is analyzed by selecting an average value for rock materials. Soils are decomposed rock and are assumed to have the same permeability. A permeability of 1.06 ($\mu = 1 + 4\pi k$, $k = 5 \cdot 10^{-3}$ cgs (ref. 9.10)) was selected. The other factor is neglected since it is assumed that the measurement is made close to the earth where the field is not greatly different from that in the earth.

The term $\left(\frac{\mu - 1}{\mu + 2}\right)$ cannot be omitted in this instance and has a value of $2 \cdot 10^{-2}$. The disturbances in the field strength surrounding the cavity are reduced by a factor $2 \cdot 10^{-2}$ from the case of the magnetized sphere. Assuming the same magnetometer sensitivity as before, the cavity can be detected at 20 radii.

UNCLASSIFIED

Hence, for a pistol, which might be approximated by an iron sphere 3" in diameter, the detection range might reasonably be 15 - 75'. A buried crate of rifles, conservatively equivalent to a 1 ft. iron sphere might be detectable at 100 feet as would a 5' radius spherical cavity. If some practical use (which is questionable) could be made of the ultimate sensitivity of vapor magnetometers, the detection distance might be increased.

In case (2), which considers a moving detector, the effect of naturally occurring magnetic regions, might be identified by their large extent compared to the localized effect of small, higher permeability targets. The large-scale noise may be identified or removed from the signal by connecting a second detector in opposition. The second detector must be approximately a hundred feet away. An alternative would be to compare the signal recorded by a single detector with that made at a base station.

Case (1) has the advantage that natural, stationary bodies will not contribute to the noise but the geomagnetic noise problem still exists. For large area surveillance, the detector could be a large loop of wire laid on the ground; however, any motion of the wire will give noise. A wire loop placed on the ground will detect a man carrying a rifle when he passes in or out of the loop (ref. 9.14). The loop can be very large but must be completely immobile.

It is difficult to estimate at this point whether such applications are practicable. They seem marginal at best. If the requirement is really a serious one -- for example, to detect buried arms stores, it may be worthwhile to run a few simple tests. Since the validity of the requirement is not known and cannot be demonstrated on logical grounds alone, no positive recommendation can be made.

9.14 Shuler, K. IDA Internal Memorandum (1902) Private Communication

-9.39-

UNCLASSIFIED

UNCLASSIFIED

MISCELLANEOUS

To complete the treatment of detection, this section contains a brief listing of uncatalogued ideas which are, respectively, a) not actionable; b) were not analyzed, or c) were completely unproductive.

The use of polygraph techniques by village-inspection teams to identify guerrillas and sympathizers, falls into the first category. Preliminary investigation indicated that this method would be technically feasible, relatively simple to use, and reliable in operation, particularly with Orientals, and could be put in the field fairly rapidly. However, it is understood that polygraphs cannot be shipped into S.E. Asian countries nor used by the military.

In the second category are a variety of possibilities ranging from straight forward applications of known methods to the development of sophisticated instruments whose basic principles have not even been defined. For example it is possible that seismic methods for a) transmitting a secure village alarm signal by detonation of a (pattern of ?) buried explosive charge(s); and reception by a directional geophone net or b) locating burrows by explosive sounding techniques, or c) geophone monitoring of canals might be feasible. Also, the use of conventional IR and visible contrast photography for surveillance of chemically or biologically inhibited food crops. Discolored or dying foliage is apparent in such photography. By this means one of the food-control programs against insurgents might be made easier. Advanced possibilities are "smoke-gradient detectors" for use under heavy canopy, and instruments to detect characteristic scents or environmentally induced skin conditions. Whereas the aforementioned

~~SECRET~~
UNCLASSIFIED

UNCLASSIFIED

ideas could be analyzed, the latter cannot, at the moment, be
basis of phenomena useful in practical instruments is not

In the last category are, respectively, suggestions for
and rice paddies with chemicals which are excited on exposure
moving personnel, and for seeding paddies, swamps and water
nescent materials in the hope of obtaining phenomena analogous
South Pacific shipwakes of World War II. A brief account of
given in an early paper (Ref. 10.1). Chemicals of interest
general problems of quantity, dispersion, and longevity were
Bioluminescent micro-organisms are not found in fresh water.

10.1 Weeks, I. "Bioluminescence Possibilities" DEC-AG-1

UNCLASSIFIED

UNCLASSIFIED

at the movent
ments is ne
suggestions
cited on exper
camps and water
phenomena analo
brief account o
als of interest
l longevity w
in fresh water

18" DEC-AG-11

UNCLASSIFIED

UNCLASSIFIED/LIMITED

Technical Report
distributed by



DEFENSE TECHNICAL INFORMATION CENTER

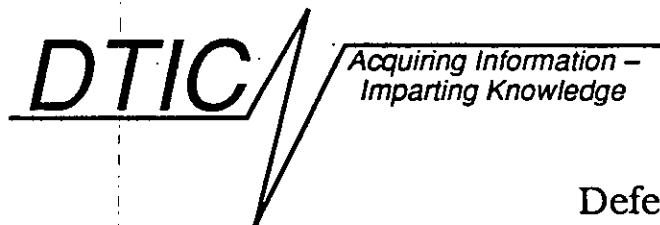

Defense Logistics Agency
Defense Technical Information Center
Cameron Station
Alexandria, Virginia 22304-6145

UNCLASSIFIED/LIMITED